



MP™ Tables

Prices effective July 1, 2024

Published July 1, 2024

General Information.....	2
How to Specify.....	4
Base Finishes	5
Casters	5
Edge Details	6
Glass	7
Grommet Finishes	7
Laminate Finishes	8
Metal Finishes	8
Paint Finishes	9
Power Modules.....	9
Stone/Marble	10
Wood Finishes.....	11
Seating Capacity	13
MP Flex Table Product Features	14-17
MP Flex Table Sample Configurations	18-20
MP Height Adjustable Table Product Features	21
MP Tables.....	22-61
MP Flex Tables	62-91
MP Height Adjustable Tables.....	92-97
Index.....	98

General Information

Terms and Conditions

Order Information

GEIGER

Application of Standard Terms

Only the standard terms of sale stated in this catalog apply to any transaction unless those terms are modified or supplemented by a written document signed by an officer of Geiger International, Inc. ("Geiger"). Any terms contained in Customer's purchase order, including standard printed provisions, that are additional to or contrary to these terms, are not effective.

Use of Furniture and Materials

Geiger assumes that textiles, leathers and products are intended for commercial use and are not being bought for use primarily for personal, family, or household purposes. When installed and used as intended, products remain chattel property, are not considered fixtures, and no interest in them should arise under applicable real estate law.

Furniture Prices

Prices are determined by using the published list prices in effect when Geiger receives Customer's completed purchase order. If Customer's requested ship date is more than three months after Geiger receives Customer's order, it may be repriced using the list prices in effect when products ship. If Customer designates special finishes or options, additional charges may apply. Services such as design, project management, packaging, storage, inside delivery, double handling, installation, or inventory management are not included in Geiger's list prices.

COM / COL Procedures

If an order includes Customer-supplied materials, Customer must ship those materials to Geiger at Customer's own expense. The materials must be tagged with Geiger's confirmation number, item number, Customer's name, and purchase order number. Geiger is not liable for inadequacies in Customer's materials. Geiger will notify Customer of any apparent defects in Customer's materials before manufacturing.

Taxes

Customer is responsible for any local sales taxes or other similar taxes imposed on transactions.

Delays

Geiger is not liable for failure to ship by the acknowledged shipping date or any other date. Geiger is not liable for a delay or failure in shipment or performance if the delay or failure is caused by acts of omission of Customer, its agents, employees, contractors, a governmental authority, or God; delays in transportation; or other similar causes that are not within Geiger's reasonable control. Geiger is excused from further performance of its obligations for the duration of a force majeure cause.

Changes and Cancellation

Geiger's acceptance of an order is final and binding and an order may not be changed or canceled without Geiger's written consent.

Orders placed on any of Geiger's expedited shipment programs and orders of custom-dyed or custom-woven materials may not be changed or canceled. To change or cancel other orders, contact Geiger Customer Care in writing for authorization and applicable charges.

Storage

If Customer cannot accept delivery when products are ready, it is the customer's responsibility to transfer products to storage and products are invoiced at that time. Customer is responsible for actual storage charges and any other expenses relating to the storage of products or materials. Customer bears all risk of loss for products or materials in storage.

Freight Terms

For casegoods and seating orders shipped within the 48 contiguous United States, surface freight charges are included. For textile and leather orders actual freight charges will be invoiced. Orders are shipped via ground carrier unless requested otherwise.

For orders shipped to Alaska or Hawaii, the freight terms stated above apply only to the port of embarkation. Shipments beyond that point are freight collect. Domestic deliveries are shipped FOB Geiger's plant to a destination designated by Customer by a method Geiger selects.

All textile shipments will be made FOB Geiger Textiles, Yaphank, NY 11980. All leather shipments will be made FOB Geiger Textiles, Hildebrand, NC 28637.

Packaging and Shipping

Geiger's casegoods products are shipped in component form. Shipments over \$50,000 net are blanket wrapped. Tops and panels are shrink wrapped with cardboard corner protection. Pedestals, storage units, overheads and vertical storage units are wrapped in blankets and shrink wrapped with cardboard corner protection. Blankets are to be returned to Geiger for reuse. If the customer request cartoning on orders over \$50,000 net, there will be a charge of five percent of the net order. Packing materials are recyclable.

Casegood shipments from Atlanta under \$50,000 net are cartoned. Cartoned shipments are packaged with cardboard channels and shrink wrap.

Geiger's seating is cartoned in boxes for all shipments. Blanket wrapping is available upon request.

If Customer requests special shipping or delivery methods, Customer is responsible for any extra costs that result.

Packaging and Shipping (continued)

Customer obtains title to products and materials and assumes the risk of loss for them upon shipment from Geiger's plant. Geiger reserves the right to make partial shipments, of truckload quantities, as products are manufactured.

Shipping Surcharge

A shipping surcharge will be added to all orders under \$100,000 list based on the ship-to address. The surcharge is a percentage of the total list price of the entire order, calculated on the base price only. Upcharges for veneer, edges, textiles, pulls, etc., are not counted in the calculation.

Zone 1	3.6% (GA, NC, SC)
Zone 2	4.2% (AL, FL, MS, TN, AR, LA)
Zone 3	4.8% (IL, IN, KY, MI, OH, WI, IA, KS, MN, MO, ND, NE, SD, DC, MD, VA)
Zone 4	5.4% (CT, MA, ME, NH, RI, VT, DE, NJ, NY, PA, WV)
Zone 5	6.0% (OK, TX, AZ, NM, NV, UT, CO)
Zone 6	6.6% (OR, WA, ID, MT WY, CA, Canada)

International Shipping

Orders for export are shipped Ex Works factory (Incoterms 2000). The charge for export packing is five percent of the net order value. There are no export packing charges on shipments to Canada.

Claims

All blanket wrapped shipments must be unwrapped and inspected at the dock, in the presence of the driver. Claims for "concealed damage" or "subject to inspection" will not be honored on blanket wrapped shipments. All cartoned shipments must be inspected for visual outside damage to the package.

Damages and piece count shortages must be noted on the bill of lading. Freight claims must be filed within 30 days (including cartoned shipments with concealed damage). Contact Customer Care for a warranty/freight claim form and send it by fax, mail or email to:

Geiger International
6095 Fulton Industrial Blvd., SW
Atlanta, GA 30336-2806
Attention: Warranty Department
Fax: 1.404.836.7519

Order Information

Herman Miller dealers must submit all purchase orders to Geiger via Omni. For assistance with this process, please contact Herman Miller Sales Technology Support at 800.833.3330.

All Geiger Gallery and non-Herman Miller dealers may submit their orders via email or fax at 404.836.7519. For assistance with this

Order Information (continued)

process, please contact Geiger Customer Care at 800.456.6452.

Midwest	custcaremw@geigerfurniture.com
New York	custcareny@geigerfurniture.com
Northeast	custcarene@geigerfurniture.com
South	custcaresouth@geigerfurniture.com
West	custcarewest@geigerfurniture.com
Int'l	custcareintl@geigerfurniture.com

Warranty

Geiger International, Inc. ("Geiger"), 6095 Fulton Industrial Blvd., SW, Atlanta, GA 30336-2806, USA, warrants the products sold by it to be free from defects in material and workmanship, regardless of the number of shifts during which the products are used, for the warranty periods specified below.

This warranty covers the sale of Geiger product in all countries. Not all of the product lines appearing on this list are marketed by Geiger in all countries, and appearance on this list does not imply an offer for sale of a product line in a particular place. Product line availability is defined in current price lists applicable to different regions.

Geiger Commercial Office Furniture Products 12 years

All products sold under the Geiger® brand name, except as limited or described below.

Textiles and Leathers 3 years

Includes, but is not limited to Edelman Leather, Geiger, Herman Miller, Maharam, and Place fabrics.

Nonstandard Products 1 to 5 years

Warranty length on nonstandard products not covered by the 12-year warranty is identified on individual product quotes.

All Other Products, Parts, and Services 2 years

Height adjustable bases (electrical parts)

5 years

Height adjustable bases (mechanical parts)
LED light strips and driver

3 years

All service parts

6 months

All other products, parts, and any services not listed above, sold or furnished by Geiger, except for consumable products such as light bulbs and other electronic products for which no warranty is given

Other Manufacturers' Products

None

Geiger will pass through to the original purchaser any warranty supplied by other manufacturers to the extent possible, including, but not limited to, open-line laminates.

Warranty (continued)

Provisions that apply to all products and services:

During the applicable warranty period, Geiger, as its sole obligation, will repair or replace (at its option) any product, part, or component covered by this warranty and sold after the effective date of this warranty, which fails under normal use as a result of a defect in material or workmanship; Geiger will repair or replace the aforementioned product, part, or component with a comparable product, part, or component.

This warranty extends only to the original purchasers who acquire new product from Geiger, or its authorized resellers. Any product, part, or component must have been installed, used, and maintained according to Geiger's published instructions in order to be eligible for coverage under this warranty and must not have been subject to misuse or abuse. Any modification to the original product voids the warranty. Geiger does not warrant the performance of the product when used in combination with other than original Geiger product.

The warranty period starts from the date of purchase.

This document inclusively describes all of the warranties given and remedies available with respect to the company's products and services. Geiger disclaims any other warranty whether express or implied, statutory or otherwise, in relation to the products.

Geiger does not warrant:

- natural variations in wood grain or figure or the presence of character marks
- changes in surface finishes due to aging or exposure to light
- marks, scars, or wrinkles occurring naturally in leather
- veins, marks, voids, fissures, or cracks found naturally in stone

In addition, Geiger does not warrant:

- failure resulting from normal wear and tear
- the matching of colors, grains, or textures of natural materials
- the colorfastness or the matching of colors of textiles, including an exact match to cuttings or to swatch cards
- damage, marking, or staining of veneer surfaces due to contact with rubber or similar compounds; damage from sharp objects or imprinting from writing instruments, or prolonged exposure to direct sunlight

Geiger tests Customer's Own Material (COM) and other customer-supplied items for manufacturing quality only and does not provide any warranty with regard to these materials.

Geiger does not warrant products that are exposed to extreme environmental conditions or that have been subject to improper storage.

Warranty (continued)

Geiger's products meet the requirements of national and specific local codes as stated in the price books and other written publications.

TO THE EXTENT ALLOWED BY LAW, ANY IMPLIED WARRANTIES, INCLUDING ANY WARRANTY OF MERCHANTABILITY OR FITNESS FOR A PARTICULAR PURPOSE, ARE DISCLAIMED AND TO THE EXTENT THEY ARE LEGALLY REQUIRED, ARE LIMITED IN DURATION TO THE DURATION OF THIS WRITTEN WARRANTY.

GEIGER SHALL NOT BE LIABLE FOR LOSS OF TIME, INCONVENIENCE, COMMERCIAL LOSS, OR INCIDENTAL OR CONSEQUENTIAL DAMAGES.

Applies in US only: Some states do not allow limitations on how long an implied warranty lasts or do not allow the exclusion or limitation of incidental or consequential damages, so the limitations or exclusions in the two preceding paragraphs may not apply. This warranty gives the purchaser specific legal rights; however, the purchaser may also have other rights that may vary from state to state.

Applies outside US: Except as stated above, Geiger will not be liable for any loss or damage (including costs) however caused, whether direct or consequential, incurred or suffered by the purchaser or any third party in respect of the products but nothing contained herein will or will be considered to exclude or restrict any liability on Geiger's part for death or personal injury resulting from negligence.

Limitations and Disclaimers

Geiger is not liable for loss of time, inconvenience, lost profits, commercial loss, or other special, consequential, or incidental damages for any transaction.

Geiger reserves the right to change its designs, its methods of construction, or its prices, charges, or policies at any time without notice to Customer.

Design Rights

The designs depicted in Geiger's catalogs and price lists are proprietary to Geiger and Geiger reserves the exclusive right to manufacture them. Any reproduction of these designs infringes Geiger's rights and that infringement will be prosecuted.

How to Specify

- For each product ordered, specify a product number string. The string should include the product number and all finish and detail codes listed at the bottom of the pricebook page.
- Specify the finishes and details in the same sequence shown on the pricebook page.
- Product Number String Example:
AM1WF-24 943 WE3 CHR
The product number string above includes all required codes for a MP round table with the following specifications:

Product Number AM1WF-24
Wood Finish..... 943 Caramel Cherry
Edge Detail..... WE3 Eased
Leg Finish..... CHR Chrome
- Basic Price reflects the price of the table without optional features. Add upcharges as shown on the product page for anigre wood finishes, solid edge detail, or base finish.

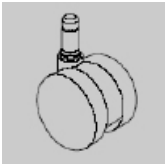
Base Finishes	Casters	
<p>Base Finishes For all MP table bases (no upcharge)</p> <p>926.....Black AS.....Arctic Silver BK.....Matte Black EH.....Metallic Bronze MS.....Metallic Silver PBZ.....Powder Coat Bronze WHTWhite</p>	<p>Casters For MP Flex tables (no upcharge)</p> <p>HDHard dual wheels, black STSoft dual wheels, black</p>	
<p>Upcharge Base Metal Finishes For all MP table bases (add upcharge shown on product page)</p> <p>CHR.....Chrome SACSatin Chrome</p>	<p>Notes</p> <p>All casters are 2" diameter and can be used with carpet.</p> <p>MP Flex table casters are locking.</p> 	

Edge Details

Basic Edge Detail

*For 1 1/8" thick laminate MP Flex table tops
(no upcharge)*

ECELaminate with PVC Eased

Basic Edge Detail

*For 1 1/4" thick wood standard and height
adjustable MP table tops
(no upcharge)*

WL3 Incline

WE3 Eased

Basic Edge Detail

*For 1 1/4" thick wood MP Flex table tops
(no upcharge)*

WE3 ... Eased

Notes

ECE edge is 1-1/8" thick
WL3 edge is 1-1/4" thick
WE3 edge is 1-1/4" thick

Glass	Grommet Finishes	
-------	------------------	--

Glass <i>For MP tables with clear glass top</i>	Grommet <i>For MP tables with one small grommet</i>	
---	---	--

GIC Clear Glass

Glass <i>For MP tables with back-painted glass top</i>	Grommet <i>For MP tables with two small grommets</i>	
--	--	--

GBP Cloud Nine
 G52 Silver Lining

SAS Arctic Silver
 S926 Black
 SBK Matte Black
 SBNZ Bronze
 SCHR Chrome
 SEH Metallic Bronze (powder-coat)
 SMS Metallic Silver (powder-coat)
 SSAC Satin Chrome
 SWHT White

Grommet <i>For MP tables with two small grommets</i>	
--	--

2SAS Arctic Silver
 2S926 Black
 2SBK Matte Black
 2SBNZ Bronze
 2SCHR Chrome
 2SEH Metallic Bronze (powder-coat)
 2SMS Metallic Silver (powder-coat)
 2SSAC Satin Chrome
 2SWHT White

Notes	
--------------	--

Small grommet is metal and provides a 1 1/2" diameter opening (without removable cover plate).



CGS1
small grommet

MP Tables

Laminates • Metal

GEIGER

Laminate Finishes	Metal Finishes	
<p>Laminate For MP Flex tables with laminate tops</p> <p>I54.....Folkstone Grey (HMI code 8Q) I60.....Soft White (HMI code LU) I65.....Chalk White (HMI code X1) I73.....Black Umber (HMI code BU) I74.....Inner Tone Light (HMI code HF) I75.....Light Tone (HMI code LT) I76.....Medium Tone (HMI code MT) I77.....Cool Grey Neutral (HMI code CL) I78.....Inner Tone (HMI code HT) I81.....Warm Grey Neutral (HMI code WN) I84.....White (HMI code 91) I92.....Studio White (HMI code 98)</p>	<p>Metal Finishes For MP Flex tables with one large grommet</p> <p>AS.....Arctic Silver CHR.....Chrome SAC.....Satin Chrome</p>	<p>Metal Finishes For height adjustable MP table desktop power units for field installation</p> <p>926.....Black AS.....Arctic Silver DN.....Dark Nickel SAC.....Satin Chrome WHT.....White</p>
<p>Notes</p> <p>When ordering samples please use HMI codes.</p>	<p>Notes</p> <p>Rectangular grommet is metal and provides a 3 1/2" x 11 5/8" rectangular opening with a flip-up lid.</p> <div data-bbox="548 682 768 819" data-label="Image"> </div> <p style="text-align: center;"><i>MP Flex rectangular grommet</i></p>	

Paint Finishes

Paint Finishes

For MP tables with back-painted glass top

- 151.....Cloud Nine
- 152.....Silver Lining

Paint Finishes

For MP tables with stone top

- 151.....Cloud Nine
- 152.....Silver Lining
- 154.....In the Black

Paint Finishes

For MP height adjustable modesty panels

- CKW.....Chalk White (matches HMI X1)
- LU.....Soft White
- 8Q.....Folkstone Gray
- 91.....White
- 151.....Cloud 9
- 152.....Silver Lining
- 153.....Pipe Dream
- 154.....In the Black
- 161.....Feather
- 162.....Saddle Up
- 163.....Coffee Talk
- 169.....Fired Up
- 171.....Swimmingly
- 172.....Sky High
- 173.....Midnight Oil
- 179.....Treatment
- 181.....Sage Advice
- 182.....Money Talks
- 183.....Ivy League
- 189.....Limelight
- 191.....The Crop
- 192.....Go for the Gold
- 193.....Bronze Age
- 199.....Spice of Life

Power Module / Plug Strip

Power Module

For MP Flex tables with power, 72" cord with 3-prong plug (no upcharge)

- PMPLG 2 power/2 data
- PMSPL 2 power/1 data/1 USB

Power Module

For MP Flex tables with power, modular connector, by-pass cable (add +\$99 upcharge)

- PNMBP 2 power/2 data
- PNSBP 2 power/1 data/1 USB

Power Module

For MP Flex tables with power, modular connector, by-pass cable, power starter kit (add +\$411 upcharge)

- PNMSK 2 power/2 data
- PNSSK 2 power/1 data/1 USB

Plug Strip

For MP height adjustable tables

- MPH..... Hardwired (add \$63)
- MPP..... Plug-in

MP Tables

Stone / Marble

GEIGER

Stone / Marble

Stone/Marble Options

For MP tables with stone/marble tops

- 200..... Perlato Marble
- 250..... Verde Antique Marble
- 400..... Black Granite
- 5U..... Georgia Grey Marble
- 800..... Autumn Brown Granite
- 960..... White Carrara Marble

Conference Tables

GEIGER

Wood Finishes



ASHT001M
ASHT001L

White Quarter Cut
Ash



OAKT002M
OAKT002L

Natural Flat Cut
Oak

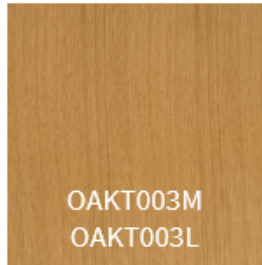

OAKT003M
OAKT003L

Natural Rift Cut
Oak

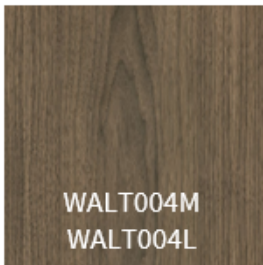

WALT004M
WALT004L

Natural Flat Cut
Walnut

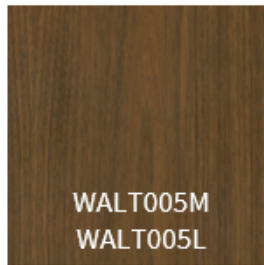

WALT005M
WALT005L

Cashmere Flat Cut
Walnut

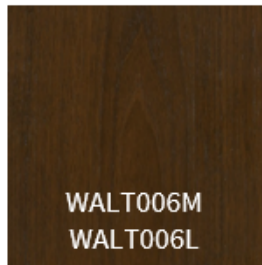

WALT006M
WALT006L

Persian Flat Cut
Walnut



ASHT007M
ASHT007L

Ebonized Flat Cut
Ash



WALR008M
WALR008L

RecoGrain Natural
Flat Cut Walnut



WALR009M
WALR009L

RecoGrain Natural
Quarter Cut Walnut



OAKR010M
OAKR010L

RecoGrain Natural
Quarter Cut Oak



ASHR011M
ASHR011L

RecoGrain Frosty
Quarter Cut Ash



OAKR012M
OAKR012L

RecoGrain Natural
Quarter Cut Rima
Oak

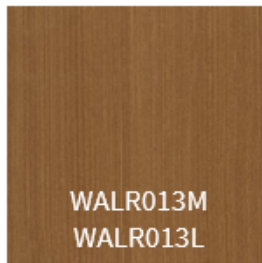

WALR013M
WALR013L

RecoGrain Natural
Quarter Cut Rima
Walnut

Seating Capacity

Seating capacity is approximate, based on 25" wide chair, and may vary according to table base design and actual chair dimensions.

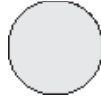

Table Size	No. Chairs
24" diameter	2
30" diameter	2
36" diameter	4
42" diameter	4
48" diameter	5



Table Size	No. Chairs
24" x 24"	4
30" x 30"	4
36" x 36"	4
42" x 42"	4
48" x 48"	4

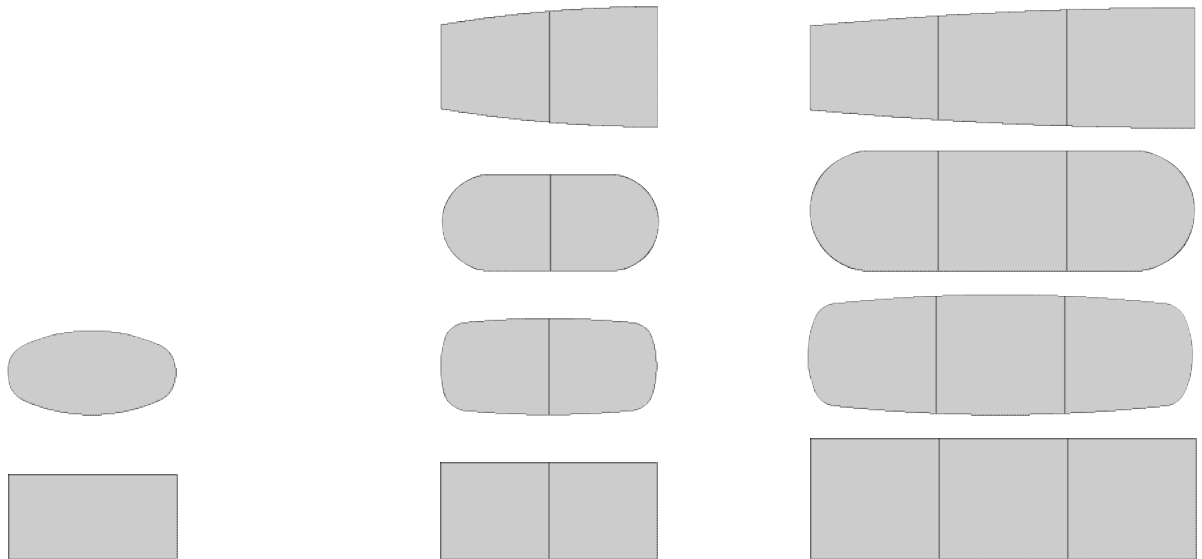

Table Size	No. Chairs
30" x 60"	4-6
30" x 66"	4-6
30" x 72"	6
36" x 60"	4-6
36" x 66"	4-6
36" x 72"	6
36" x 78"	6
36" x 84"	6-8
36" x 90"	6-8
36" x 96"	8
42" x 78"	6
42" x 84"	6-8
42" x 90"	6-8
42" x 96"	8
48" x 84"	6-8
48" x 90"	6-8
48" x 96"	8

Table Size	No. Chairs
42" x 108"	8-10
42" x 120"	10
42" x 132"	10
42" x 144"	10-12
42" x 156"	12
42" x 168"	12-14
42" x 180"	14
48" x 108"	8-10
48" x 120"	10
48" x 132"	10
48" x 144"	10-12
48" x 156"	12
48" x 168"	12-14
48" x 180"	14
54" x 108"	8-10
54" x 120"	10-12
54" x 132"	10-12
54" x 144"	10-12
54" x 156"	12-14
54" x 168"	12-14
54" x 180"	14-16
60" x 108"	10
60" x 120"	10-12
60" x 132"	10-12
60" x 144"	10-12
60" x 156"	12-14
60" x 168"	12-14
60" x 180"	14-16

Table Size	No. Chairs
42" x 192"	14
42" x 204"	14-16
42" x 216"	16
42" x 228"	16-18
42" x 240"	18
48" x 192"	14
48" x 204"	14-16
48" x 216"	16
48" x 228"	16-18
48" x 240"	18
54" x 192"	14-16
54" x 204"	16-18
54" x 216"	16-18
54" x 228"	18-20
54" x 240"	18-20
60" x 192"	14-16
60" x 204"	16-18
60" x 216"	16-18
60" x 228"	18
60" x 240"	18-20

Flex Table Nesting

A single finger-pull mechanism at the front edge of each table releases the flip mechanism, allowing it to tilt to 90 degrees and lock into position. Tables can be rolled out of the way and nested with a 5-1/2" offset front to back and a 5" offset side to side. Rubber bumpers on the inside of the metal columns prevent damage to the adjacent table top when nested. Optional modesty panels are hinged, so as the table top is flipped into a nesting position, the modesty panel also eases into a nesting position.

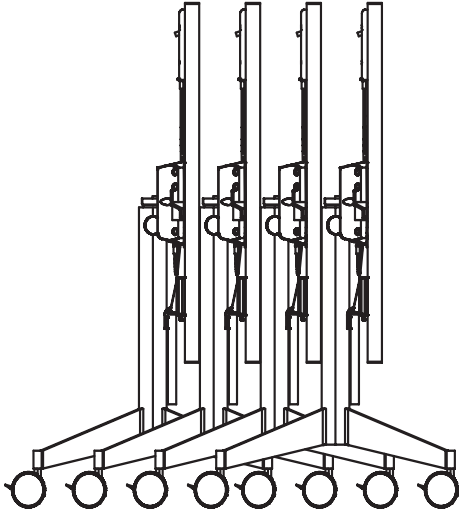
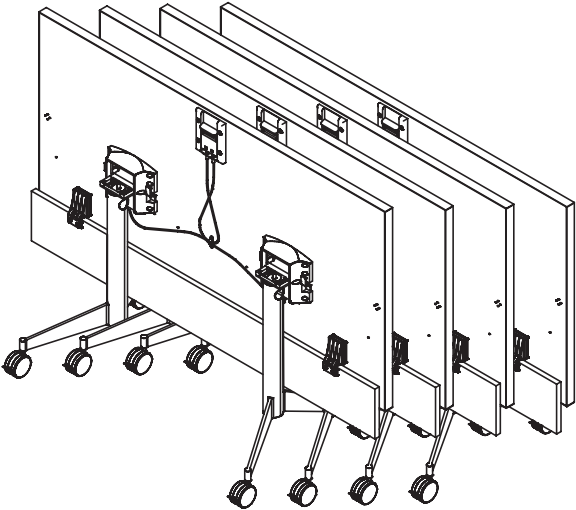
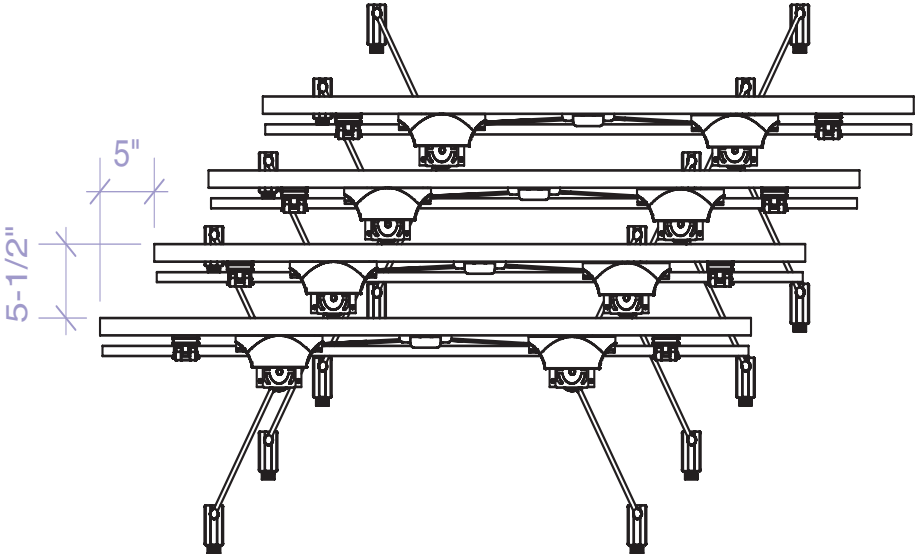

MP Tables

MP Flex Tables • Ganging

GEIGER

Flex Table Ganging

MP Flex Tables can be joined using the MP Flex ganging bracket to form various conferencing/training configurations. Ganging brackets are ordered separately as needed. Order one AMGM-1 kit for each side connection and two AMGM-1 kits for each back to back connection. All rectangular, trapezoid and half-round tables are pre-drilled to accept ganging brackets. For best results, ganged tables should be installed on level floors.

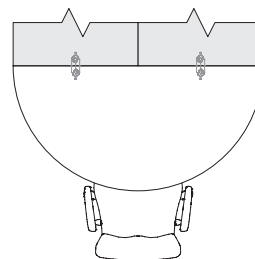
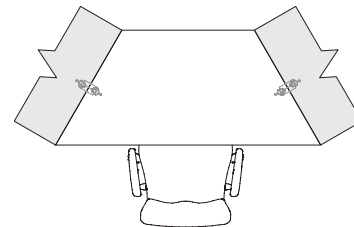
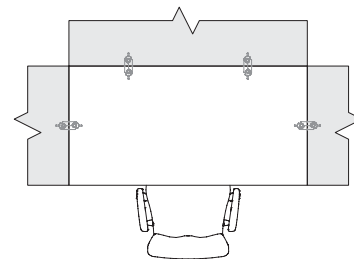
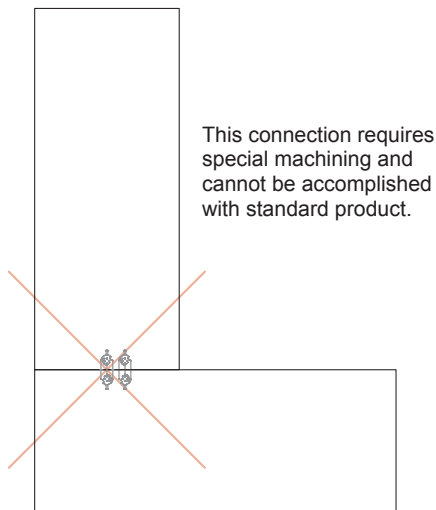
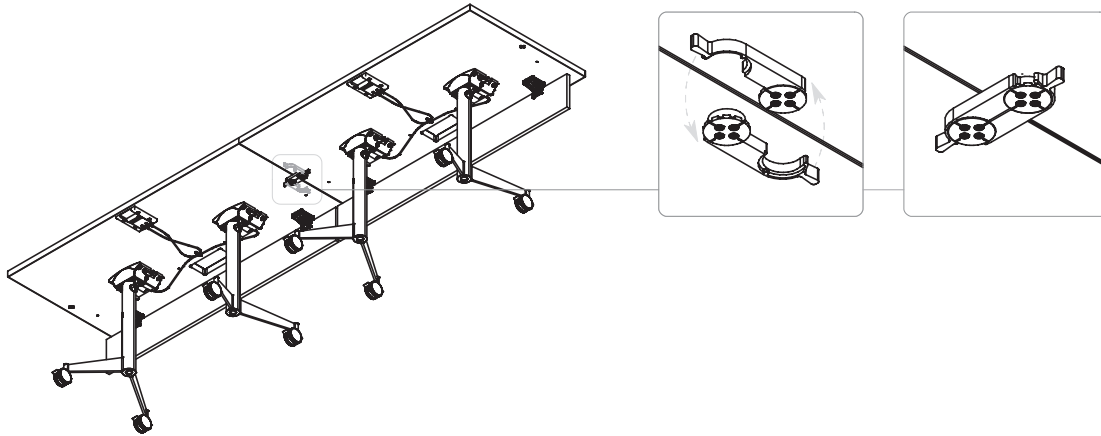

Flex Table Modesty Panels

MP Flex Tables can be ordered with an optional flip-down modesty panel in wood or laminate. Tops come pre-drilled to accept modesty panel brackets so modesty panels can be retrofitted at a later date as well. Modesty panels are field removable without the need for tools simply by depressing a lever tab on each bracket and sliding the panel off the brackets.

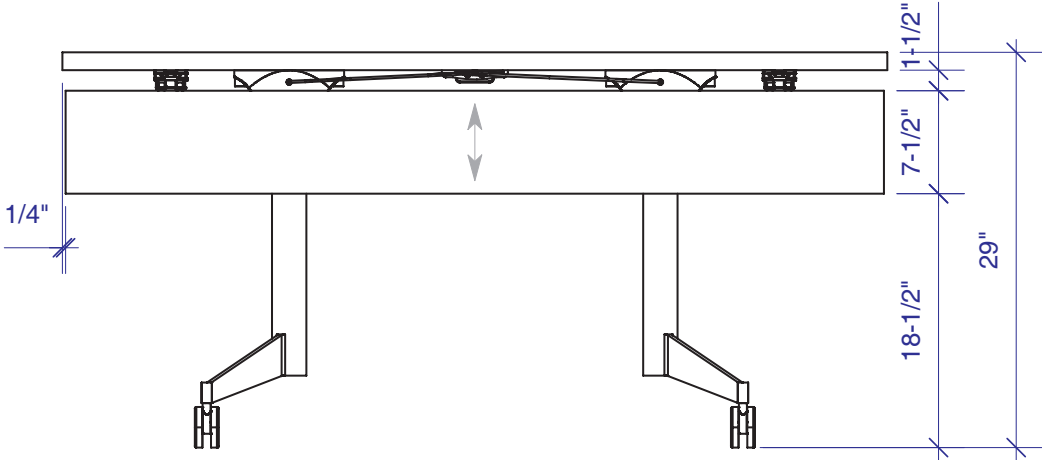
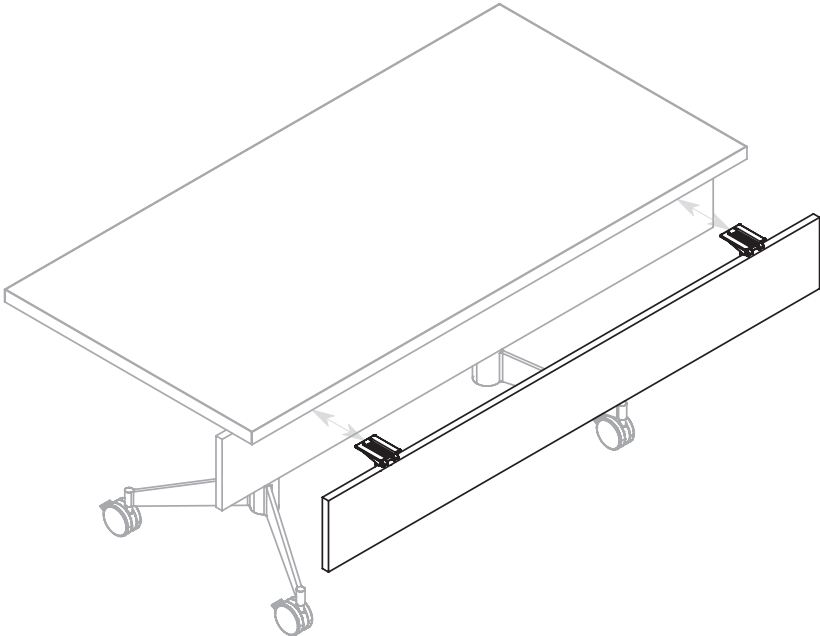

MP Tables

MP Flex Tables • Power

GEIGER

Flex Table Power

MP Flex Tables can be ordered with an optional tabletop power module covered by a fluid, one-touch door that remains open during use. Constructed of clear anodized aluminum, this unit consists of two power outlets and two slots for voice/data connections. It includes a voice/data adapter kit (A/V adapter kits and voice/data jacks sold separately). The power module is UL Listed and available with either a 15-amp cord or a modular, intelligent interlinking system allowing up to four tables (eight power modules or jumper cables) to be interconnected from a single infeed. This modular system includes an LED indicator that lights "green" when power is supplied and lights "red" when there are too many units linked together on a single power infeed.

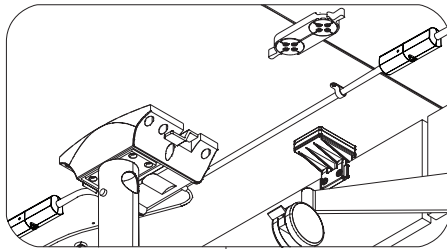

The Jumper Cable carries power across unpowered tables as well as extending power to the adjoining table as needed. When a table is specified with the interlinking connection system, it will ship with the appropriate jumper cable relative to the table's size.



Power Module
(as seen from table top)

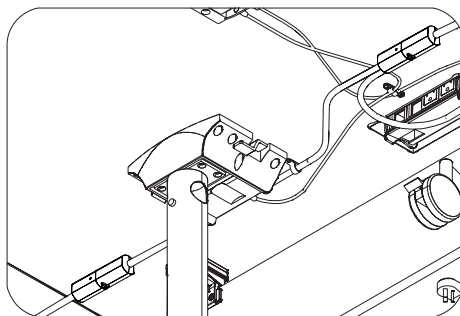
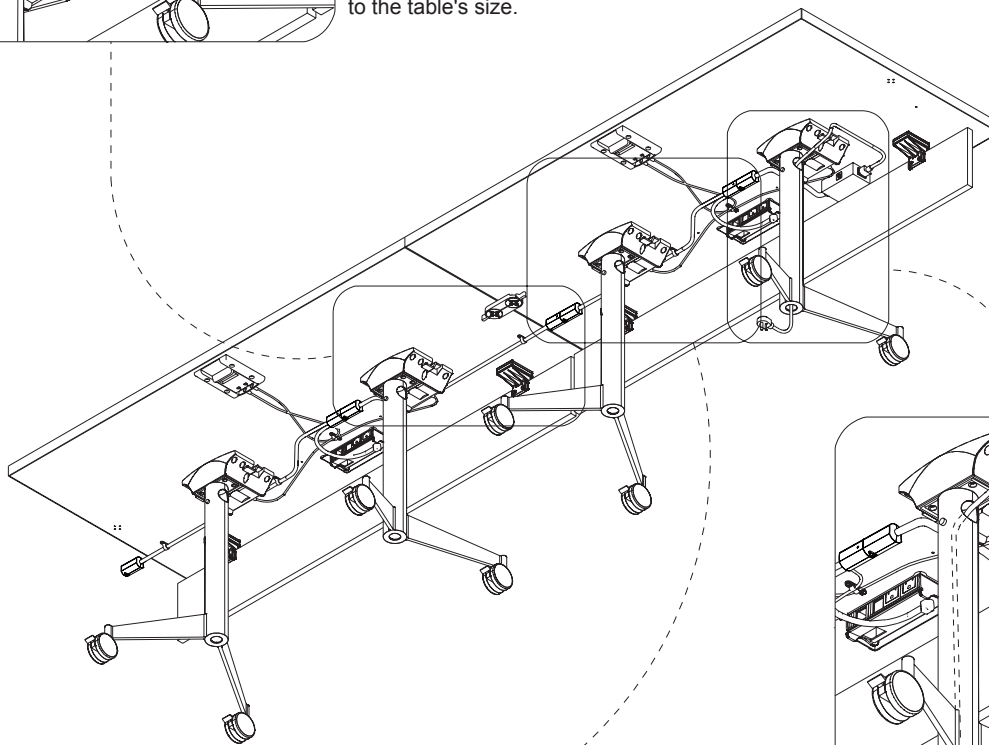

The Power Module includes a 12" cable with modular connector to join to either a Power Starter Kit or a Jumper Cable, and a longer, varying length cable with modular connector to join with an adjacent table's power.

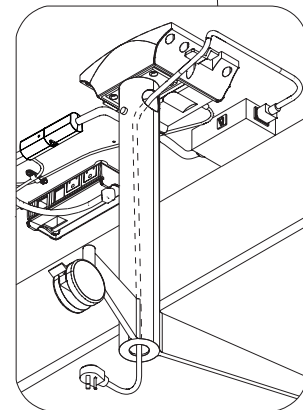

The Power Starter Kit brings power into the modular system and connects to the Power Module. The Power Starter Kit includes a 6' cable with three-prong plug which can be fed through a 1-1/2" hole at the top of the column, through the interior of the base and out a 2-3/8" hole at the bottom, creating a clean transition from tabletop to floor.

Flex Table Sample Configurations

Samples shown have Arctic Silver bases, modular power components, ganging mechanisms and modesty panels (where applicable).

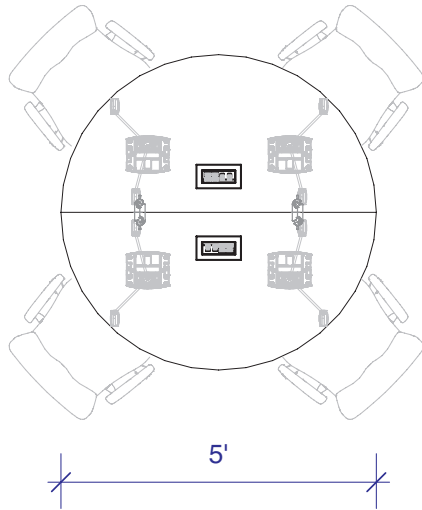

QTY Description

- 1 AMHWMP-60
30D x 60W x 29-1/4H
MP Multi-Use, Half Round
Table, Wood Top, Casters,
Power Module
- 1 Power Starter Kit (Option)
- 1 AMHWMP-60
30D x 60W x 29-1/4H
MP Multi-Use, Half Round
Table, Wood Top, Casters,
Power Module
- 1 Jumper Cable (Option)
- 2 AMGM-1
Ganging Kit

Total

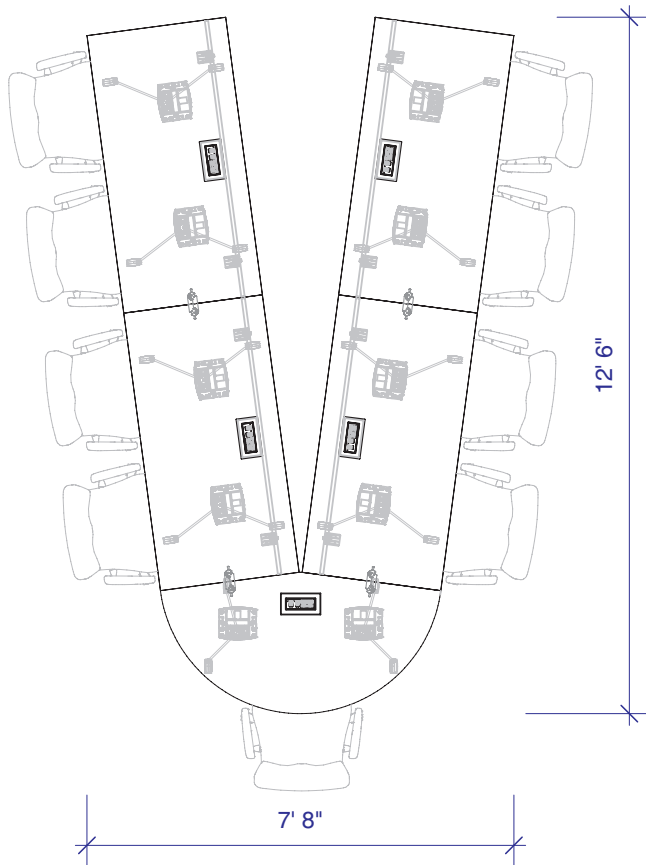

QTY Description

- 2 AM3WMP-3060
30D x 60W x 29-1/4H
MP Multi-Use, Rectangular
Table, Wood Top, Casters,
Power Module
- 2 Power Starter Kit (Option)
- 2 AM3WMP-3060
30D x 60W x 29-1/4H
MP Multi-Use, Rectangular
Table, Wood Top, Casters,
Power Module
- 2 Jumper Cable (Option)
- 1 AMVWMP-60
30D x 60W x 29-1/4H
MP Multi-Use, Video Conf
End Table, Wood Top, Casters,
Power Module
- 1 Jumper Cable (Option)
- 4 AMMWM-60
3/4D x 59-1/2W x 7 1/2H
MP Multi-Use Flip Down
Modesty Panel, Wood
- 4 AMGM-1
Ganging Kit

Total

MP Tables

MP Flex Tables • Sample Configurations

GEIGER

Flex Table Sample Configurations

Samples shown have Arctic Silver bases, modular power components, ganging mechanisms and modesty panels (where applicable).

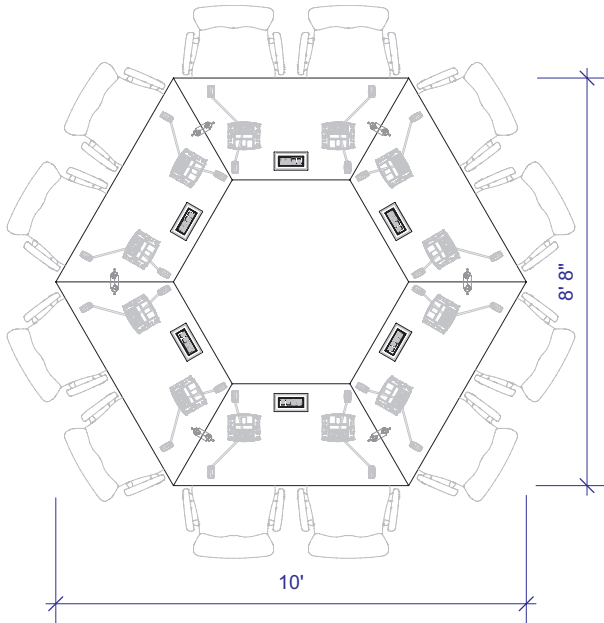

QTY	Description	Each	Ext Price
2	AMZWMP-2660 26D x 60W x 29-1/4H MP Multi-Use, Trapezoid Table, Wood Top, Casters, Power Module	\$5,773	\$11,546
2	Power Starter Kit (Option)	\$411	\$822
4	AMZWMP-2660 26D x 60W x 29-1/4H MP Multi-Use, Trapezoid Table, Wood Top, Casters, Power Module	\$5,773	\$23,092
4	Jumper Cable (Option)	\$148	\$592
6	AMGM-1 Ganging kit	\$103	\$618
6	AMMWM-30 3/4D x 29-1/2W x 7 1/2H MP Multi-Use Flip Down Modesty Panel, Wood	\$989	\$5,934
Total			\$42,604

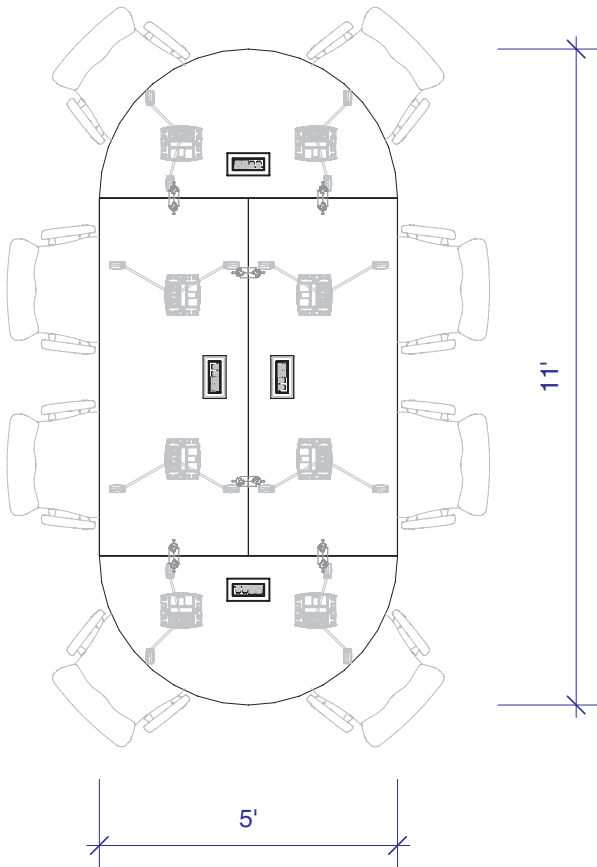

QTY	Description	Each	Ext Price
1	AMHWMP-60 30D x 60W x 29-1/4H MP Multi-Use, Half Round Table, Wood Top, Casters, Power Module	\$5,587	\$5,587
1	Power Starter Kit (Option)	\$411	\$411
1	AMHWMP-60 30D x 60W x 29-1/4H MP Multi-Use, Half Round Table, Wood Top, Casters, Power Module	\$5,587	\$5,587
1	Jumper Cable (Option)	\$148	\$148
2	AM3WMP-3060 30D x 60W x 29-1/4H MP Multi-Use, Rectangular Table, Wood Top, Casters, Power Module	\$5,501	\$11,002
2	Jumper Cable (Option)	\$148	\$296
4	AMGM-1 Ganging Kit	\$103	\$412
Total			\$23,295

Flex Table Sample Configurations

Samples shown have Arctic Silver bases, modular power components, ganging mechanisms and modesty panels (where applicable).

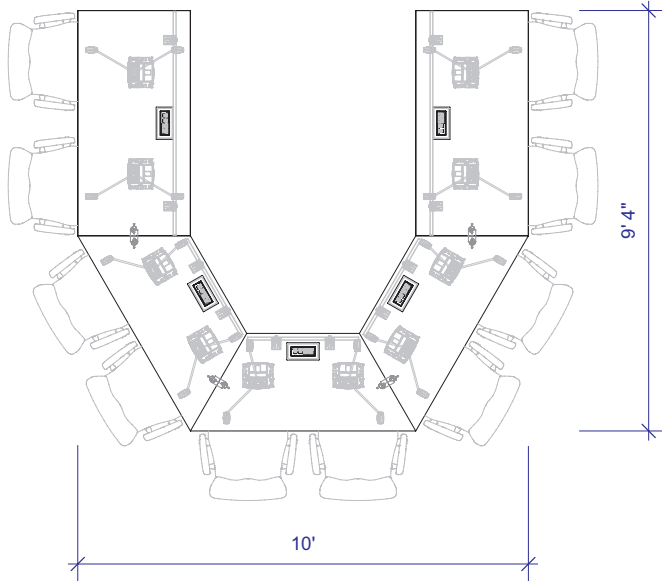

QTY	Description	Each	Ext Price
2	AM3WMP-3060 30D x 60W x 29-1/4H MP Multi-Use, Rectangular Table, Wood Top, Casters, Power Module	\$5,501	\$11,002
2	Power Starter Kit (Option)	\$411	\$822
3	AMZWMP-2660 26D x 60W x 29-1/4H MP Multi-Use, Trapezoid Table, Wood Top, Casters, Power Module	\$5,773	\$17,319
3	Jumper Cable (Option)	\$148	\$444
2	AMMWM-60 3/4D x 59-1/2W x 7 1/2H MP Multi-Use Flip Down Modesty Panel, Wood	\$1,046	\$2,092
3	AMMWM-30 3/4D x 29-1/2W x 7 1/2H MP Multi-Use Flip Down Modesty Panel, Wood	\$989	\$2,967
4	AMGM-1 Ganging Kit	\$103	\$412
Total			\$35,058

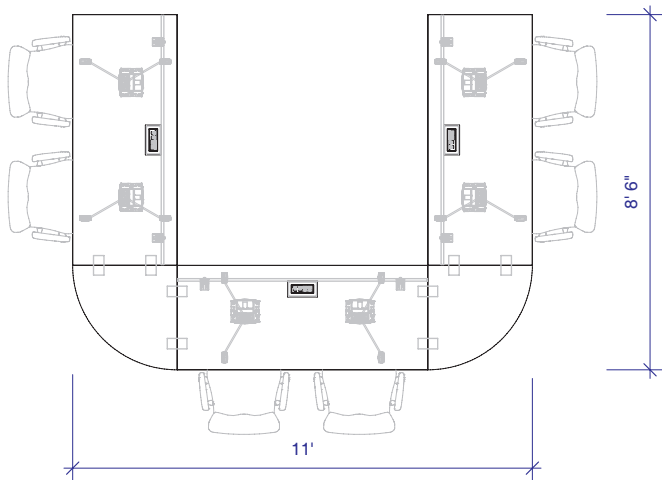

QTY	Description	Each	Ext Price
2	AM3WMP-3072 30D x 72W x 29-1/4H MP Multi-Use, Rectangular Table, Wood Top, Casters, Power Module	\$5,566	\$11,132
2	Power Starter Kit (Option)	\$411	\$822
1	AM3WMP-3072 30D x 72W x 29-1/4H MP Multi-Use, Rectangular Table, Wood Top, Casters, Power Module	\$5,566	\$5,566
1	Jumper Cable (Option)	\$148	\$148
3	AMMWM-72 3/4D x 71-1/2W x 7 1/2H MP Multi-Use Flip Down Modesty Panel, Wood	\$1,082	\$3,246
2	AMCWMN-3030 30D x 30W x 1-1/4H MP Multi-Use, Rounded Corner, Wood Top Includes Flat Plates and Jumper Cable (Option)	\$1,964	\$3,928
2	Jumper Cable (Option)	\$148	\$296
Total			\$25,138

MP Tables

Product Features • MP Height Adjustable Tables

GEIGER

MP Height Adjustable Tables Product Features

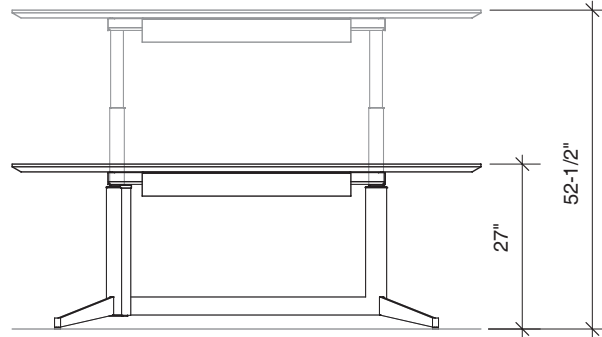

Each table includes a 4-outlet plug strip that can be specified with a 9' cord with a 3-prong plug or with knockouts for hardwiring in the field.

Each table comes standard with a hinged metal trough under the top between the base posts, secured with two latches, to conceal and manage cables.

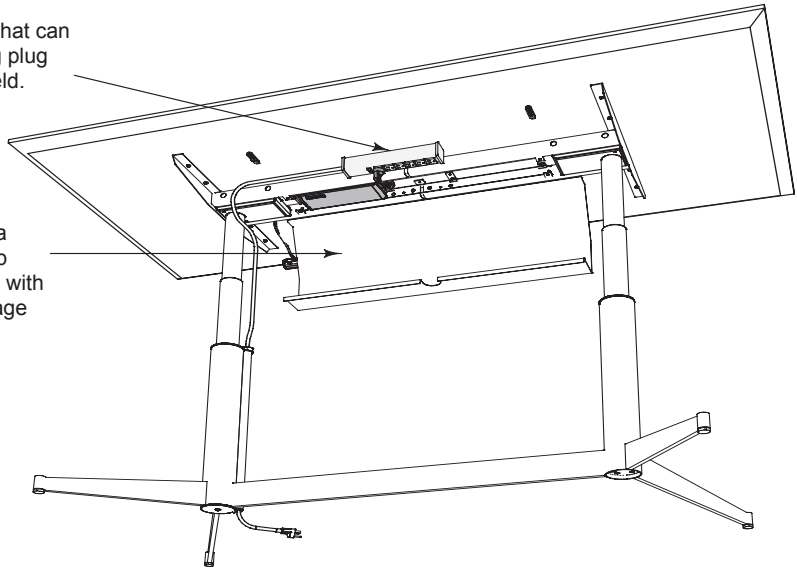

The controller is mounted on user side of the table and includes five buttons (up, down and 2 programmable presets and a lock feature). An LCD panel displays the height of the table. Additionally there are two USB ports on the side of the controller.

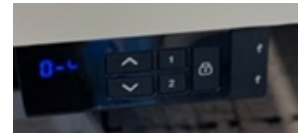

The optional modesty panel is available as a mitered three sided panel or a straight front panel in either a painted finish or vertical grained veneer.

The plug strip cord is managed from the top of the table base up to the plug strip by a flexible fabric sleeve which prevents the cable from sagging downwards as table height is adjusted.

The vertical cable manager conceals the plug strip cord alongside the table base. The finish matches that of the table base.

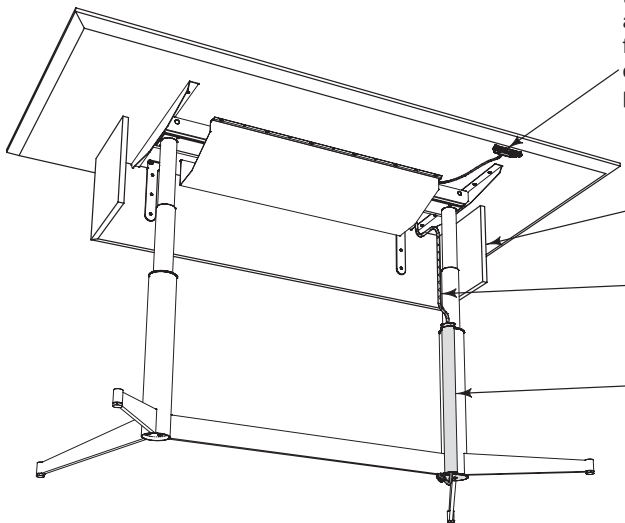

	Product Number	Depth	Width	Height	Basic Price	Base
MP • Round occasional height wood top	<i>1 1/4" wood top</i>					
	AM1WF-24	24	24	16 1/4	\$1,880	+398
	AM1WF-30	30	30	16 1/4	\$2,188	+398
	AM1WF-36	36	36	16 1/4	\$2,469	+398
	AM1WF-42	42	42	16 1/4	\$3,015	+398
	AM1WF-48	48	48	16 1/4	\$3,410	+398



Top.....wood veneered with specified edge detail
Basemetal

MP • Round occasional height wood top with one grommet	<i>1 1/4" wood top</i>					
	AM1WH-24	24	24	16 1/4	\$2,037	+398
	AM1WH-30	30	30	16 1/4	\$2,353	+398
	AM1WH-36	36	36	16 1/4	\$2,635	+398
	AM1WH-42	42	42	16 1/4	\$3,180	+398
	AM1WH-48	48	48	16 1/4	\$3,576	+398



Top.....wood veneered with specified edge detail
Basemetal

Specify

- Wood
- Edge
- Base
- Grommet (for tables with grommets)

MP Tables

Round • Glass Top • Occasional Height

GEIGER

	Product Number	Depth	Width	Height	Basic Price	Base
MP • Round occasional height glass top 	<i>clear glass top</i>					
	AM1CO-24	24	24	16	\$2,754	+534
	AM1CO-30	30	30	16	\$3,105	+534
	AM1CO-36	36	36	16	\$3,308	+534
	AM1CO-42	42	42	16	\$3,883	+534
	AM1CO-48	48	48	16	\$4,264	+534
	<i>back-painted glass top</i>					
	AM1BF-24	24	24	16 1/4	\$2,843	+398
	AM1BF-30	30	30	16 1/4	\$3,352	+398
	AM1BF-36	36	36	16 1/4	\$4,032	+398
AM1BF-42	42	42	16 1/4	\$4,916	+398	
AM1BF-48	48	48	16 1/4	\$5,699	+398	

Clear glass top..... 1/2" thick low iron, non-tempered clear glass
 Back-painted glass top 1/2" thick low iron, back-painted glass with 3/4" thick painted MDF subtop
 Base metal

Specify

Glass
 Paint (for back-painted glass top tables)
 Base

	Product Number	Depth	Width	Height	Basic Price	Base
MP • Round <i>lounge height</i> wood top 	<i>1 1/4" wood top</i>					
	AM1WK-24	24	24	26	\$1,917	+398
	AM1WK-30	30	30	26	\$2,247	+398
	AM1WK-36	36	36	26	\$2,531	+398
	AM1WK-42	42	42	26	\$3,099	+398
	AM1WK-48	48	48	26	\$3,496	+398

Top.....wood veneered with specified edge detail
Basemetal

	Product Number	Depth	Width	Height	Basic Price	Base
MP • Round <i>lounge height</i> wood top with one grommet 	<i>1 1/4" wood top</i>					
	AM1WM-24	24	24	26	\$2,083	+398
	AM1WM-30	30	30	26	\$2,403	+398
	AM1WM-36	36	36	26	\$2,694	+398
	AM1WM-42	42	42	26	\$3,261	+398
	AM1WM-48	48	48	26	\$3,657	+398

Top.....wood veneered with specified edge detail
Basemetal

Specify

- Wood
- Edge
- Base
- Grommet (for tables with grommets)

MP Tables

Round • Glass Top • Lounge Height

GEIGER

	Product Number	Depth	Width	Height	Basic Price	Base
MP • Round lounge height glass top 	<i>clear glass top</i>					
	AM1CL-24	24	24	25 3/4	\$2,859	+534
	AM1CL-30	30	30	25 3/4	\$3,180	+534
	AM1CL-36	36	36	25 3/4	\$3,376	+534
	AM1CL-42	42	42	25 3/4	\$3,956	+534
	AM1CL-48	48	48	25 3/4	\$4,338	+534
	<i>back-painted glass top</i>					
	AM1BK-24	24	24	26	\$2,881	+398
	AM1BK-30	30	30	26	\$3,410	+398
	AM1BK-36	36	36	26	\$4,091	+398
AM1BK-42	42	42	26	\$4,996	+398	
AM1BK-48	48	48	26	\$5,779	+398	

Clear glass top..... 1/2" thick low iron, non-tempered clear glass
 Back-painted glass top 1/2" thick low iron, back-painted glass with 3/4" thick painted MDF subtop
 Base metal

Specify

Glass
 Paint (for back-painted glass top tables)
 Base

	Product Number	Depth	Width	Height	Basic Price	Base
MP • Round desk height wood top	<i>1 1/4" wood top</i>					
	AM1WB-30	30	30	28 3/4	\$2,247	+398
	AM1WB-36	36	36	28 3/4	\$2,531	+398
	AM1WB-42	42	42	28 3/4	\$3,099	+398
	AM1WB-48	48	48	28 3/4	\$3,496	+398



Top.....wood veneered with specified edge detail
Basemetal

MP • Round desk height wood top with one grommet	<i>1 1/4" wood top</i>					
	AM1WD-30	30	30	28 3/4	\$2,403	+398
	AM1WD-36	36	36	28 3/4	\$2,694	+398
	AM1WD-42	42	42	28 3/4	\$3,261	+398
	AM1WD-48	48	48	28 3/4	\$3,657	+398



Top.....wood veneered with specified edge detail
Basemetal

Specify

- Wood
- Edge
- Base
- Grommet (for tables with grommets)

MP Tables

Round • Glass Top • Desk height

GEIGER

	Product Number	Depth	Width	Height	Basic Price	Base
MP • Round desk height glass top 	<i>clear glass top</i>					
	AM1CD-24	24	24	28 1/2	\$2,859	+534
	AM1CD-30	30	30	28 1/2	\$3,180	+534
	AM1CD-36	36	36	28 1/2	\$3,376	+534
	AM1CD-42	42	42	28 1/2	\$3,956	+534
	AM1CD-48	48	48	28 1/2	\$4,338	+534
	<i>back-painted glass top</i>					
	AM1BB-24	24	24	28 3/4	\$2,881	+398
	AM1BB-30	30	30	28 3/4	\$3,410	+398
	AM1BB-36	36	36	28 3/4	\$4,091	+398
AM1BB-42	42	42	28 3/4	\$4,996	+398	
AM1BB-48	48	48	28 3/4	\$5,779	+398	

Clear glass top..... 1/2" thick low iron, non-tempered clear glass
 Back-painted glass top..... 1/2" thick low iron, back-painted glass with 3/4" thick painted MDF subtop
 Base metal

Specify

Glass
 Paint (for back-painted glass top tables)
 Base

	Product Number	Depth	Width	Height	Basic Price	Base
MP • Round café height wood top	<i>1 1/4" wood top</i>					
	AM1WP-30	30	30	42	\$2,358	+398
	AM1WP-36	36	36	42	\$2,642	+398
	AM1WP-42	42	42	42	\$3,174	+398
	AM1WP-48	48	48	42	\$3,560	+398



Top.....wood veneered with specified edge detail
Basemetal

MP • Round café height wood top with one grommet	<i>1 1/4" wood top</i>					
	AM1WR-30	30	30	42	\$2,524	+398
	AM1WR-36	36	36	42	\$2,806	+398
	AM1WR-42	42	42	42	\$3,336	+398
	AM1WR-48	48	48	42	\$3,727	+398



Top.....wood veneered with specified edge detail
Basemetal

Specify

- Wood
- Edge
- Base
- Grommet (for tables with grommets)

MP Tables

Round • Glass Top • Café Height

GEIGER

	Product Number	Depth	Width	Height	Basic Price	Base
MP • Round café height glass top 	<i>clear glass top</i>					
	AM1CC-24	24	24	41 3/4	\$2,843	+534
	AM1CC-30	30	30	41 3/4	\$3,293	+534
	AM1CC-36	36	36	41 3/4	\$3,496	+534
	AM1CC-42	42	42	41 3/4	\$4,082	+534
	AM1CC-48	48	48	41 3/4	\$4,466	+534
	<i>back-painted glass top</i>					
	AM1BP-30	30	30	42	\$3,525	+398
	AM1BP-36	36	36	42	\$4,203	+398
	AM1BP-42	42	42	42	\$5,070	+398
AM1BP-48	48	48	42	\$5,856	+398	

Clear glass top..... 1/2" thick low iron, non-tempered clear glass
 Back-painted glass top 1/2" thick low iron, back-painted glass with 3/4" thick painted MDF subtop
 Base metal

Specify

Glass
 Paint (for back-painted glass top tables)
 Base

	Product Number	Depth	Width	Height	Basic Price	Base
MP • Square occasional height wood top 	<i>1 1/4" wood top</i>					
	AM2WF-2424	24	24	16 1/4	\$1,880	+398
	AM2WF-3030	30	30	16 1/4	\$2,103	+398
	AM2WF-3636	36	36	16 1/4	\$2,374	+398
	AM2WF-4242	42	42	16 1/4	\$2,899	+398
AM2WF-4848	48	48	16 1/4	\$3,278	+398	

Top.....wood veneered with specified edge detail
Basemetal

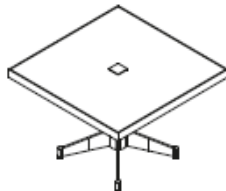
	Product Number	Depth	Width	Height	Basic Price	Base
MP • Square occasional height wood top with one grommet 	<i>1 1/4" wood top</i>					
	AM2WH-2424	24	24	16 1/4	\$2,037	+398
	AM2WH-3030	30	30	16 1/4	\$2,353	+398
	AM2WH-3636	36	36	16 1/4	\$2,635	+398
	AM2WH-4242	42	42	16 1/4	\$3,180	+398
AM2WH-4848	48	48	16 1/4	\$3,576	+398	

Top.....wood veneered with specified edge detail
Basemetal

Specify

- Wood
- Edge
- Base
- Grommet (for tables with grommets)

MP Tables

Square • Glass Top • Occasional Height

GEIGER

	Product Number	Depth	Width	Height	Basic Price	Base
MP • Square occasional height glass top 	<i>clear glass top</i>					
	AM2CO-2424	24	24	16	\$2,822	+534
	AM2CO-3030	30	30	16	\$3,091	+534
	AM2CO-3636	36	36	16	\$3,397	+534
	AM2CO-4242	42	42	16	\$3,980	+534
	AM2CO-4848	48	48	16	\$4,370	+534
	<i>back-painted glass top</i>					
	AM2BF-2424	24	24	16 1/4	\$2,843	+398
	AM2BF-3030	30	30	16 1/4	\$3,352	+398
	AM2BF-3636	36	36	16 1/4	\$4,032	+398
AM2BF-4242	42	42	16 1/4	\$4,916	+398	
AM2BF-4848	48	48	16 1/4	\$5,699	+398	

Clear glass top..... 1/2" thick low iron, non-tempered clear glass
 Back-painted glass top 1/2" thick low iron, back-painted glass with 3/4" thick painted MDF subtop
 Base metal

Specify

Glass
 Paint (for back-painted glass top tables)
 Base

	Product Number	Depth	Width	Height	Basic Price	Base
MP • Square lounge height wood top	1 1/4" wood top					
	AM2WK-2424	24	24	26	\$1,917	+398
	AM2WK-3030	30	30	26	\$2,247	+398
	AM2WK-3636	36	36	26	\$2,531	+398
	AM2WK-4242	42	42	26	\$3,099	+398
	AM2WK-4848	48	48	26	\$3,496	+398

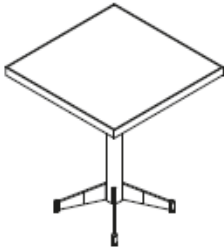

Top.....wood veneered with specified edge detail
 Basemetal

MP • Square lounge height wood top with one grommet	1 1/4" wood top					
	AM2WM-2424	24	24	26	\$2,083	+398
	AM2WM-3030	30	30	26	\$2,403	+398
	AM2WM-3636	36	36	26	\$2,694	+398
	AM2WM-4242	42	42	26	\$3,261	+398
	AM2WM-4848	48	48	26	\$3,657	+398

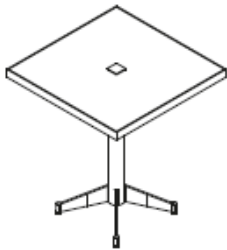

Top.....wood veneered with specified edge detail
 Basemetal

Specify

- Wood
- Edge
- Base
- Grommet (for tables with grommets)

MP Tables

Square • Glass Top • Lounge Height

GEIGER

	Product Number	Depth	Width	Height	Basic Price	Base
MP • Square lounge height glass top 	<i>clear glass top</i>					
	AM2CL-2424	24	24	25 3/4	\$2,928	+534
	AM2CL-3030	30	30	25 3/4	\$3,166	+534
	AM2CL-3636	36	36	25 3/4	\$3,471	+534
	AM2CL-4242	42	42	25 3/4	\$4,055	+534
	AM2CL-4848	48	48	25 3/4	\$4,434	+534
	<i>back-painted glass top</i>					
	AM2BK-2424	24	24	26	\$2,881	+398
	AM2BK-3030	30	30	26	\$3,410	+398
	AM2BK-3636	36	36	26	\$4,091	+398
AM2BK-4242	42	42	26	\$4,996	+398	
AM2BK-4848	48	48	26	\$5,779	+398	

Clear glass top..... 1/2" thick low iron, non-tempered clear glass
 Back-painted glass top 1/2" thick low iron, back-painted glass with 3/4" thick painted MDF subtop
 Base metal

Specify

Glass
 Paint (for back-painted glass top tables)
 Base

	Product Number	Depth	Width	Height	Basic Price	Base
MP • Square desk height wood top	<i>1 1/4" wood top</i>					
	AM2WB-3030	30	30	28 3/4	\$2,247	+398
	AM2WB-3636	36	36	28 3/4	\$2,531	+398
	AM2WB-4242	42	42	28 3/4	\$3,099	+398
	AM2WB-4848	48	48	28 3/4	\$3,496	+398

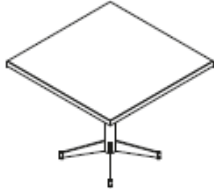

Top.....wood veneered with specified edge detail
Basemetal

	Product Number	Depth	Width	Height	Basic Price	Base
MP • Square desk height wood top with one grommet	<i>1 1/4" wood top</i>					
	AM2WD-3030	30	30	28 3/4	\$2,403	+364 +398
	AM2WD-3636	36	36	28 3/4	\$2,694	+437 +398
	AM2WD-4242	42	42	28 3/4	\$3,261	+510 +398
	AM2WD-4848	48	48	28 3/4	\$3,657	+582 +398



Top.....wood veneered with specified edge detail
Basemetal

Specify

- Wood
- Edge
- Base
- Grommet (for tables with grommets)

MP Tables

Square • Glass Top • Desk Height

GEIGER

	Product Number	Depth	Width	Height	Basic Price	Base
MP • Square desk height glass top 	<i>clear glass top</i>					
	AM2CD-2424	24	24	28 1/2	\$2,928	+534
	AM2CD-3030	30	30	28 1/2	\$3,166	+534
	AM2CD-3636	36	36	28 1/2	\$3,471	+534
	AM2CD-4242	42	42	28 1/2	\$4,055	+534
	AM2CD-4848	48	48	28 1/2	\$4,434	+534
	<i>back-painted glass top</i>					
	AM2BB-2424	24	24	28 3/4	\$2,881	+398
	AM2BB-3030	30	30	28 3/4	\$3,410	+398
	AM2BB-3636	36	36	28 3/4	\$4,091	+398
AM2BB-4242	42	42	28 3/4	\$4,996	+398	
AM2BB-4848	48	48	28 3/4	\$5,779	+398	

Clear glass top..... 1/2" thick low iron, non-tempered clear glass
 Back-painted glass top 1/2" thick low iron, back-painted glass with 3/4" thick painted MDF subtop
 Base metal

Specify

Glass
 Paint (for back-painted glass top tables)
 Base

	Product Number	Depth	Width	Height	Basic Price	Base
MP • Square café height wood top	<i>1 1/4" wood top</i>					
	AM2WP-3030	30	30	42	\$2,358	+398
	AM2WP-3636	36	36	42	\$2,642	+398
	AM2WP-4242	42	42	42	\$3,174	+398
	AM2WP-4848	48	48	42	\$3,560	+398



*Top.....wood veneered with specified edge detail
Basemetal*

MP • Square café height wood top with one grommet	<i>1 1/4" wood top</i>					
	AM2WR-3030	30	30	42	\$2,524	+398
	AM2WR-3636	36	36	42	\$2,806	+398
	AM2WR-4242	42	42	42	\$3,336	+398
	AM2WR-4848	48	48	42	\$3,727	+398



*Top.....wood veneered with specified edge detail
Basemetal*

Specify

- Wood
- Edge
- Base
- Grommet (for tables with grommets)

MP Tables

Square • Glass Top • Café Height

GEIGER

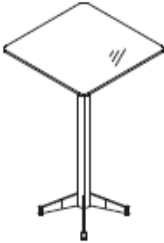
	Product Number	Depth	Width	Height	Basic Price	Base
MP • Square café height glass top 	<i>clear glass top</i>					
	AM2CC-2424	24	24	41 3/4	\$2,910	+534
	AM2CC-3030	30	30	41 3/4	\$3,279	+534
	AM2CC-3636	36	36	41 3/4	\$3,585	+534
	AM2CC-4242	42	42	41 3/4	\$4,189	+534
	AM2CC-4848	48	48	41 3/4	\$4,570	+534
	<i>back-painted glass top</i>					
	AM2BP-3030	30	30	42	\$3,525	+398
	AM2BP-3636	36	36	42	\$4,203	+398
	AM2BP-4242	42	42	42	\$5,070	+398
AM2BP-4848	48	48	42	\$5,856	+398	

Clear glass top..... 1/2" thick low iron, non-tempered clear glass
 Back-painted glass top 1/2" thick low iron, back-painted glass with 3/4" thick painted MDF subtop
 Base metal

Specify

Glass
 Paint (for back-painted glass top tables)
 Base

	Product Number	Depth	Width	Height	Basic Price	Base
MP • Rectangular lounge height wood top, two bases 	<i>1 1/4" wood top</i>					
	AM3WK-3060	30	60	26	\$3,674	+766
	AM3WK-3066	30	66	26	\$3,822	+766
	AM3WK-3072	30	72	26	\$3,980	+766
	AM3WK-3660	36	60	26	\$3,936	+766
	AM3WK-3666	36	66	26	\$4,115	+766
	AM3WK-3672	36	72	26	\$4,294	+766
	AM3WK-3678	36	78	26	\$4,547	+766
	AM3WK-3684	36	84	26	\$4,731	+766
	AM3WK-4278	42	78	26	\$5,273	+766
	AM3WK-4284	42	84	26	\$5,480	+766

Top..... wood veneered with specified edge detail

Basemetal

Specify

Wood
 Edge
 Base

MP Tables

Rectangular • Wood Top • Lounge Height

GEIGER

	Product Number	Depth	Width	Height	Basic Price	Base
MP • Rectangular lounge height wood top with two grommets, two bases	<i>1 1/4" wood top</i>					
	AM3WM-3060	30	60	26 1/4	\$3,849	+766
	AM3WM-3066	30	66	26 1/4	\$3,992	+766
	AM3WM-3072	30	72	26 1/4	\$4,140	+766
	AM3WM-3660	36	60	26 1/4	\$4,091	+766
	AM3WM-3666	36	66	26 1/4	\$4,272	+766
	AM3WM-3672	36	72	26 1/4	\$4,444	+766
	AM3WM-3678	36	78	26 1/4	\$4,690	+766
	AM3WM-3684	36	84	26 1/4	\$4,868	+766
	AM3WM-4278	42	78	26 1/4	\$5,386	+766
	AM3WM-4284	42	84	26 1/4	\$5,587	+766



Top.....wood veneered with specified edge detail

Basemetal

Specify

Wood
 Edge
 Base
 Grommet

	Product Number	Depth	Width	Height	Basic Price	Base
MP • Rectangular lounge height glass top, two bases 	<i>clear glass top</i>					
	AM3CL-3060	30	60	25 3/4	\$5,456	+890
	AM3CL-3066	30	66	25 3/4	\$5,699	+890
	AM3CL-3072	30	72	25 3/4	\$5,952	+890
	AM3CL-3660	36	60	25 3/4	\$5,795	+890
	AM3CL-3666	36	66	25 3/4	\$6,066	+890
	AM3CL-3672	36	72	25 3/4	\$6,364	+890

Clear glass top..... 1/2" thick low iron, non-tempered clear glass
 Base metal

Specify

Glass
 Base

MP Tables

Rectangular • Glass Top • Lounge Height

GEIGER

	Product Number	Depth	Width	Height	Basic Price	Base
MP • Rectangular lounge height <i>back-painted glass top, two bases</i> 	<i>back-painted glass top</i>					
	AM3BK-3060	30	60	26	\$5,624	+766
	AM3BK-3066	30	66	26	\$5,907	+766
	AM3BK-3072	30	72	26	\$6,199	+766
	AM3BK-3660	36	60	26	\$6,148	+766
	AM3BK-3666	36	66	26	\$6,484	+766
	AM3BK-3672	36	72	26	\$6,817	+766
	AM3BK-3678	36	78	26	\$7,228	+766
	AM3BK-3684	36	84	26	\$7,573	+766
	AM3BK-4278	42	78	26	\$8,299	+766
	AM3BK-4284	42	84	26	\$8,455	+766

Back-painted glass top 1/2" thick low iron, back-painted glass with 3/4" thick painted MDF subtop
Base metal

Specify

- Glass
- Paint
- Base

	Product Number	Depth	Width	Height	Basic Price	Base
MP • Rectangular desk height one-piece wood top, two bases 	<i>1 1/4" wood top</i>					
	AM3WB-3060	30	60	28 3/4	\$3,674	+766
	AM3WB-3066	30	66	28 3/4	\$3,822	+766
	AM3WB-3072	30	72	28 3/4	\$3,980	+766
	AM3WB-3660	36	60	28 3/4	\$3,936	+766
	AM3WB-3666	36	66	28 3/4	\$4,115	+766
	AM3WB-3672	36	72	28 3/4	\$4,294	+766
	AM3WB-3678	36	78	28 3/4	\$4,547	+766
	AM3WB-3684	36	84	28 3/4	\$4,731	+766
	AM3WB-3690	36	90	28 3/4	\$4,916	+766
	AM3WB-3696	36	96	28 3/4	\$5,093	+766
	AM3WB-4278	42	78	28 3/4	\$5,273	+766
	AM3WB-4284	42	84	28 3/4	\$5,480	+766
	AM3WB-4290	42	90	28 3/4	\$5,691	+766
	AM3WB-4296	42	96	28 3/4	\$5,900	+766
	AM3WB-4884	48	84	28 3/4	\$5,849	+766
	AM3WB-4890	48	90	28 3/4	\$6,078	+766
	AM3WB-4896	48	96	28 3/4	\$6,318	+766

Top..... wood veneered with specified edge detail

Basemetal

Corners.....mitered

Specify

Wood
Edge
Base

MP Tables

Rectangular • Wood Top • Desk Height

GEIGER

	Product Number	Depth	Width	Height	Basic Price	Base
MP • Rectangular desk height one-piece wood top with two grommets, two bases 	<i>1 1/4" wood top</i>					
	AM3WD-3060	30	60	28 3/4	\$4,003	+766
	AM3WD-3066	30	66	28 3/4	\$4,152	+766
	AM3WD-3072	30	72	28 3/4	\$4,306	+766
	AM3WD-3660	36	60	28 3/4	\$4,255	+766
	AM3WD-3666	36	66	28 3/4	\$4,443	+766
	AM3WD-3672	36	72	28 3/4	\$4,622	+766
	AM3WD-3678	36	78	28 3/4	\$4,878	+766
	AM3WD-3684	36	84	28 3/4	\$5,063	+766
	AM3WD-3690	36	90	28 3/4	\$5,243	+766
	AM3WD-3696	36	96	28 3/4	\$5,421	+766
	AM3WD-4278	42	78	28 3/4	\$5,602	+766
	AM3WD-4284	42	84	28 3/4	\$5,811	+766
	AM3WD-4290	42	90	28 3/4	\$6,015	+766
	AM3WD-4296	42	96	28 3/4	\$6,221	+766
	AM3WD-4884	48	84	28 3/4	\$6,176	+766
	AM3WD-4890	48	90	28 3/4	\$6,408	+766
	AM3WD-4896	48	96	28 3/4	\$6,641	+766

Top..... wood veneered with specified edge detail
 Base metal
 Corners..... mitered

Specify

- Wood
- Edge
- Base
- Grommet

	Product Number	Depth	Width	Height	Basic Price	Base
MP • Rectangular desk height two-piece wood top, two bases 	<i>1 1/4" wood top</i>					
	AM3WF-42108	42	108	28 3/4	\$7,081	+979
	AM3WF-42120	42	120	28 3/4	\$7,611	+979
	AM3WF-48108	48	108	28 3/4	\$7,381	+979
	AM3WF-48120	48	120	28 3/4	\$7,940	+979
	AM3WF-54108	54	108	28 3/4	\$8,038	+979
	AM3WF-54120	54	120	28 3/4	\$8,664	+979
	AM3WF-60108	60	108	28 3/4	\$8,372	+979
	AM3WF-60120	60	120	28 3/4	\$9,037	+979

Top..... wood veneered with specified edge detail

Base metal

Corners..... mitered

Specify

Wood
Edge
Base

	Product Number	Depth	Width	Height	Basic Price	Base
MP • Rectangular desk height two-piece wood top, three bases 	<i>1 1/4" wood top</i>					
	AM3WF-42132	42	132	28 3/4	\$9,778	+1,583
	AM3WF-42144	42	144	28 3/4	\$10,324	+1,583
	AM3WF-42156	42	156	28 3/4	\$10,904	+1,583
	AM3WF-42168	42	168	28 3/4	\$11,450	+1,583
	AM3WF-42180	42	180	28 3/4	\$11,990	+1,583
	AM3WF-48132	48	132	28 3/4	\$10,144	+1,583
	AM3WF-48144	48	144	28 3/4	\$10,720	+1,583
	AM3WF-48156	48	156	28 3/4	\$11,339	+1,583
	AM3WF-48168	48	168	28 3/4	\$11,915	+1,583
	AM3WF-48180	48	180	28 3/4	\$12,482	+1,583
	AM3WF-54132	54	132	28 3/4	\$10,958	+1,583
	AM3WF-54144	54	144	28 3/4	\$11,602	+1,583
	AM3WF-54156	54	156	28 3/4	\$12,288	+1,583
	AM3WF-54168	54	168	28 3/4	\$12,930	+1,583
	AM3WF-54180	54	180	28 3/4	\$13,564	+1,583
	AM3WF-60132	60	132	28 3/4	\$11,360	+1,583
	AM3WF-60144	60	144	28 3/4	\$12,043	+1,583
	AM3WF-60156	60	156	28 3/4	\$12,766	+1,583
	AM3WF-60168	60	168	28 3/4	\$13,445	+1,583
	AM3WF-60180	60	180	28 3/4	\$14,118	+1,583

Top.....wood veneered with specified edge detail
 Basemetal
 Corners.....mitered

Specify

Wood
 Edge
 Base

	Product Number	Depth	Width	Height	Basic Price	Base
MP • Rectangular desk height three-piece wood top, four bases 	<i>1 1/4" wood top</i>					
	AM3WF-42192	42	192	28 3/4	\$14,163	+2,189
	AM3WF-42204	42	204	28 3/4	\$14,754	+2,189
	AM3WF-42216	42	216	28 3/4	\$15,283	+2,189
	AM3WF-42228	42	228	28 3/4	\$15,830	+2,189
	AM3WF-42240	42	240	28 3/4	\$16,365	+2,189
	AM3WF-48192	48	192	28 3/4	\$14,694	+2,189
	AM3WF-48204	48	204	28 3/4	\$15,314	+2,189
	AM3WF-48216	48	216	28 3/4	\$15,882	+2,189
	AM3WF-48228	48	228	28 3/4	\$16,456	+2,189
	AM3WF-48240	48	240	28 3/4	\$17,025	+2,189
	AM3WF-54192	54	192	28 3/4	\$15,867	+2,189
	AM3WF-54204	54	204	28 3/4	\$16,553	+2,189
	AM3WF-54216	54	216	28 3/4	\$17,191	+2,189
	AM3WF-54228	54	228	28 3/4	\$17,824	+2,189
	AM3WF-54240	54	240	28 3/4	\$18,467	+2,189
	AM3WF-60192	60	192	28 3/4	\$16,448	+2,189
	AM3WF-60204	60	204	28 3/4	\$17,173	+2,189
	AM3WF-60216	60	216	28 3/4	\$17,846	+2,189
	AM3WF-60228	60	228	28 3/4	\$18,527	+2,189
	AM3WF-60240	60	240	28 3/4	\$19,199	+2,189

Top..... wood veneered with specified edge detail

Basemetal

Corners.....mitered

Specify

Wood
Edge
Base

	Product Number	Depth	Width	Height	Basic Price	Base
MP • Rectangular desk height glass top, two bases 	<i>clear glass top</i>					
	AM3CD-3060	30	60	28 1/2	\$5,456	+890
	AM3CD-3066	30	66	28 1/2	\$5,699	+890
	AM3CD-3072	30	72	28 1/2	\$5,952	+890
	AM3CD-3660	36	60	28 1/2	\$5,795	+890
	AM3CD-3666	36	66	28 1/2	\$6,066	+890
	AM3CD-3672	36	72	28 1/2	\$6,364	+890

Clear glass top..... 1/2" thick low iron, non-tempered clear glass
 Base metal

Specify

Glass
 Base

MP Tables

Rectangular • Back-Painted Glass Top • Desk Height

GEIGER

	Product Number	Depth	Width	Height	Basic Price	Base
MP • Rectangular	<i>back-painted glass top</i>					
desk height	AM3BB-3060	30	60	28 3/4	\$5,624	+766
back-painted glass top, two bases	AM3BB-3066	30	66	28 3/4	\$5,907	+766
	AM3BB-3072	30	72	28 3/4	\$6,199	+766
	AM3BB-3660	36	60	28 3/4	\$6,148	+766
	AM3BB-3666	36	66	28 3/4	\$6,484	+766
	AM3BB-3672	36	72	28 3/4	\$6,817	+766
	AM3BB-3678	36	78	28 3/4	\$7,228	+766
	AM3BB-3684	36	84	28 3/4	\$7,573	+766
	AM3BB-4278	42	78	28 3/4	\$8,299	+766
	AM3BB-4284	42	84	28 3/4	\$8,455	+766



*Back-painted glass top 1/2" thick low iron, back-painted glass with 3/4" thick painted MDF subtop
Base metal*

Specify

- Glass
- Paint
- Base

	Product Number	Depth	Width	Height	Basic Price	Base
MP • Oblong lounge height wood top, two bases 	<i>1 1/4" wood top</i>					
	AM5WK-3660	36	60	26	\$3,936	+766
	AM5WK-3666	36	66	26	\$4,115	+766
	AM5WK-3672	36	72	26	\$4,294	+766
	AM5WK-3678	36	78	26	\$4,547	+766
	AM5WK-4278	42	78	26	\$5,273	+766
	AM5WK-4284	42	84	26	\$5,480	+766
	Top.....wood veneered with specified edge detail Basemetal					

MP • Oblong lounge height wood top with two grommets, two bases 	<i>1 1/4" wood top</i>					
	AM5WM-3660	36	60	26	\$4,255	+766
	AM5WM-3666	36	66	26	\$4,443	+766
	AM5WM-3672	36	72	26	\$4,622	+766
	AM5WM-3678	36	78	26	\$4,878	+766
	AM5WM-4278	42	78	26	\$5,602	+766
	AM5WM-4284	42	84	26	\$5,811	+766
	Top.....wood veneered with specified edge detail Basemetal					

Specify

- Wood
- Edge
- Base
- Grommet (for tables with grommets)

MP Tables

Oblong • Back-Painted Glass Top • Lounge Height

GEIGER

	Product Number	Depth	Width	Height	Basic Price	Base
MP • Oblong	<i>back-painted glass top</i>					
lounge height	AM5BK-3660	36	60	26	\$6,148	+766
back-painted glass top, two bases	AM5BK-3666	36	66	26	\$6,484	+766
	AM5BK-3672	36	72	26	\$6,817	+766
	AM5BK-3678	36	78	26	\$7,228	+766
	AM5BK-4278	42	78	26	\$8,299	+766
	AM5BK-4284	42	84	26	\$8,692	+766



*Back-painted glass top 1/2" thick low iron, back-painted glass with 3/4" thick painted MDF subtop
Base metal*

Specify

- Glass
- Paint
- Base

	Product Number	Depth	Width	Height	Basic Price	Base
MP • Oblong desk height wood top two bases 	<i>1 1/4" wood top</i>					
	AM5WB-3660	36	60	28 3/4	\$3,936	+766
	AM5WB-3666	36	66	28 3/4	\$4,115	+766
	AM5WB-3672	36	72	28 3/4	\$4,294	+766
	AM5WB-3678	36	78	28 3/4	\$4,547	+766
	AM5WB-4278	42	78	28 3/4	\$5,273	+766
	AM5WB-4284	42	84	28 3/4	\$5,480	+766
	AM5WB-4290	42	90	28 3/4	\$5,691	+766
	AM5WB-4884	48	84	28 3/4	\$5,849	+766
	AM5WB-4890	48	90	28 3/4	\$6,078	+766
	AM5WB-4896	48	96	28 3/4	\$6,318	+766

Top..... wood veneered with specified edge detail
Base metal
Corners..... radiused

Specify

Wood
 Edge
 Base

MP Tables

Oblong • Wood Top • Desk Height

GEIGER

	Product Number	Depth	Width	Height	Basic Price	Base
MP • Oblong desk height wood top with two grommets, two bases <hr/> 	1 1/4" wood top					
	AM5WD-3660	36	60	29	\$4,255	+766
	AM5WD-3666	36	66	29	\$4,443	+766
	AM5WD-3672	36	72	29	\$4,622	+766
	AM5WD-3678	36	78	29	\$4,878	+766
	AM5WD-4278	42	78	29	\$5,602	+766
	AM5WD-4284	42	84	29	\$5,811	+766
	AM5WD-4290	42	90	29	\$6,015	+766
	AM5WD-4884	48	84	29	\$6,176	+766
	AM5WD-4890	48	90	29	\$6,408	+766
AM5WD-4896	48	96	29	\$6,641	+766	

Top.....wood veneered with specified edge detail

Basemetal

Corners.....radiused

Specify

- Wood
- Edge
- Base
- Grommet

	Product Number	Depth	Width	Height	Basic Price	Base
MP • Oblong desk height two-piece wood top, two bases	<i>1 1/4" wood top</i>					
	AM8WF-48108	48	108	28 3/4	\$7,381	+979
	AM8WF-48120	48	120	28 3/4	\$7,940	+979
	AM8WF-54120	54	120	28 3/4	\$8,664	+979
	AM8WF-60120	60	120	28 3/4	\$9,037	+979



Top.....wood veneered with specified edge detail

Basemetal

Corners.....radiused

Specify

Wood
 Edge
 Base

	Product Number	Depth	Width	Height	Basic Price	Base
MP • Oblong desk height two-piece wood top, three bases	<i>1 1/4" wood top</i>					
	AM8WF-54132	54	132	28 3/4	\$11,002	+1,583
	AM8WF-54144	54	144	28 3/4	\$11,638	+1,583
	AM8WF-54156	54	156	28 3/4	\$12,334	+1,583
	AM8WF-54168	54	168	28 3/4	\$12,969	+1,583
	AM8WF-60132	60	132	28 3/4	\$11,406	+1,583
	AM8WF-60144	60	144	28 3/4	\$12,077	+1,583
	AM8WF-60156	60	156	28 3/4	\$12,811	+1,583
	AM8WF-60168	60	168	28 3/4	\$13,484	+1,583
	AM8WF-60180	60	180	28 3/4	\$14,163	+1,583



Top.....wood veneered with specified edge detail

Basemetal

Corners.....radiused

Specify

Wood
Edge
Base

	Product Number	Depth	Width	Height	Basic Price	Base
MP • Oblong desk height three-piece wood top, four bases	<i>1 1/4" wood top</i>					
	AM8WF-60192	60	192	28 3/4	\$16,531	+2,189
	AM8WF-60204	60	204	28 3/4	\$17,263	+2,189
	AM8WF-60216	60	216	28 3/4	\$17,929	+2,189
	AM8WF-60228	60	228	28 3/4	\$18,607	+2,189
AM8WF-60240	60	240	28 3/4	\$19,280	+2,189	



Top.....wood veneered with specified edge detail

Basemetal

Corners.....radiused

Specify

Wood
 Edge
 Base
 Power

MP Tables

Oblong • Glass Top • Desk Height

GEIGER

	Product Number	Depth	Width	Height	Basic Price	Base
MP • Oblong desk height glass top, two bases 	<i>back-painted glass top</i>					
	AM5BB-3660	36	60	28 3/4	\$6,148	+766
	AM5BB-3666	36	66	28 3/4	\$6,484	+766
	AM5BB-3672	36	72	28 3/4	\$6,817	+766
	AM5BB-3678	36	78	28 3/4	\$7,228	+766
	AM5BB-4278	42	78	28 3/4	\$8,299	+766
	AM5BB-4284	42	84	28 3/4	\$8,692	+766

*Back-painted glass top 1/2" thick low iron, back-painted glass with 3/4" thick painted MDF subtop
 Base metal*

Specify

- Glass
- Paint
- Base

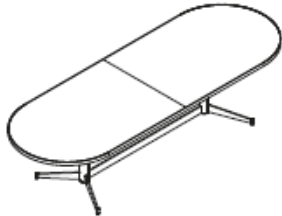
	Product Number	Depth	Width	Height	Basic Price	Base
MP • Racetrack desk height two-piece wood top, two bases 	<i>1 1/4" wood top</i>					
	AM4WF-42120	42	120	28 3/4	\$7,313	+979
	AM4WF-42132	42	132	28 3/4	\$7,841	+979
	AM4WF-48120	48	120	28 3/4	\$7,640	+979
	AM4WF-48132	48	132	28 3/4	\$8,206	+979
	AM4WF-54120	54	120	28 3/4	\$8,372	+979
	AM4WF-54132	54	132	28 3/4	\$9,002	+979
	AM4WF-60120	60	120	28 3/4	\$8,740	+979
	AM4WF-60132	60	132	28 3/4	\$9,404	+979

Top.....wood veneered with specified edge detail

Basemetal

Corners.....radiused

Specify

Wood
Edge
Base

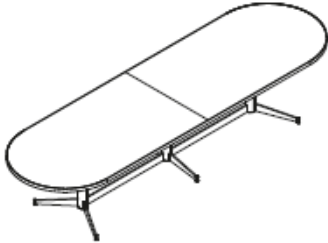
	Product Number	Depth	Width	Height	Basic Price	Base
MP • Racetrack desk height two-piece wood top, three bases 	<i>1 1/4" wood top</i>					
	AM4WF-42144	42	144	28 3/4	\$10,008	+1,583
	AM4WF-42156	42	156	29	\$10,547	+1,583
	AM4WF-42168	42	168	29	\$11,146	+1,583
	AM4WF-42180	42	180	29	\$11,682	+1,583
	AM4WF-48144	48	144	29	\$10,404	+1,583
	AM4WF-48156	48	156	29	\$10,981	+1,583
	AM4WF-48168	48	168	29	\$11,608	+1,583
	AM4WF-48180	48	180	29	\$12,174	+1,583
	AM4WF-54144	54	144	29	\$11,294	+1,583
	AM4WF-54156	54	156	29	\$11,929	+1,583
	AM4WF-54168	54	168	29	\$12,622	+1,583
	AM4WF-54180	54	180	29	\$13,260	+1,583
	AM4WF-60144	60	144	29	\$11,735	+1,583
	AM4WF-60156	60	156	29	\$12,406	+1,583
	AM4WF-60168	60	168	29	\$13,132	+1,583
	AM4WF-60180	60	180	29	\$13,812	+1,583

Top..... wood veneered with specified edge detail

Basemetal

Corners.....radiused

Specify

Wood
 Edge
 Base

	Product Number	Depth	Width	Height	Basic Price	Base
MP • Racetrack desk height three-piece wood top, four bases	<i>1 1/4" wood top</i>					
	AM4WF-42192	42	192	29	\$13,856	+2,189
	AM4WF-42204	42	204	29	\$14,394	+2,189
	AM4WF-42216	42	216	29	\$14,985	+2,189
	AM4WF-42228	42	228	29	\$15,515	+2,189
	AM4WF-42240	42	240	29	\$16,059	+2,189
	AM4WF-48192	48	192	29	\$14,386	+2,189
	AM4WF-48204	48	204	29	\$14,956	+2,189
	AM4WF-48216	48	216	29	\$15,583	+2,189
	AM4WF-48228	48	228	29	\$16,143	+2,189
	AM4WF-48240	48	240	29	\$16,718	+2,189
	AM4WF-54192	54	192	29	\$15,559	+2,189
	AM4WF-54204	54	204	29	\$16,194	+2,189
	AM4WF-54216	54	216	29	\$16,890	+2,189
	AM4WF-54228	54	228	29	\$17,517	+2,189
	AM4WF-54240	54	240	29	\$18,152	+2,189
	AM4WF-60192	60	192	29	\$16,143	+2,189
	AM4WF-60204	60	204	29	\$16,820	+2,189
	AM4WF-60216	60	216	29	\$17,547	+2,189
	AM4WF-60228	60	228	29	\$18,213	+2,189
AM4WF-60240	60	240	29	\$18,892	+2,189	



Top..... wood veneered with specified edge detail

Basemetal

Corners.....radiused

Specify

Wood
Edge
Base

	Product Number	Depth	Width	Height	Basic Price	Base
MP • Half Boat	<i>1 1/4" wood top</i>					
desk height	AM9WF-60108	60	108	29	\$8,401	+979
two-piece wood top, two bases	AM9WF-60120	60	120	29	\$9,068	+979



Top..... wood veneered with specified edge detail
Basemetal
Corners.....mitered

Specify

Wood
 Edge
 Base

	Product Number	Depth	Width	Height	Basic Price	Base
MP • Half Boat desk height two-piece wood top, three bases	<i>1 1/4" wood top</i>					
	AM9WF-60132	60	132	28 3/4	\$11,398	+1,583
	AM9WF-60144	60	144	28 3/4	\$12,072	+1,583
	AM9WF-60156	60	156	28 3/4	\$12,805	+1,583
	AM9WF-60168	60	168	28 3/4	\$13,474	+1,583
	AM9WF-60180	60	180	28 3/4	\$14,155	+1,583



Top..... wood veneered with specified edge detail
Base metal
Corners..... mitered

Specify

Wood
 Edge
 Base

	Product Number	Depth	Width	Height	Basic Price	Base
MP • Half Boat desk height three-piece wood top, four bases	<i>1 1/4" wood top</i>					
	AM9WF-60192	60	192	28 3/4	\$16,523	+2,189
	AM9WF-60204	60	204	28 3/4	\$17,255	+2,189
	AM9WF-60216	60	216	28 3/4	\$17,920	+2,189
	AM9WF-60228	60	228	28 3/4	\$18,594	+2,189
AM9WF-60240	60	240	28 3/4	\$19,274	+2,189	

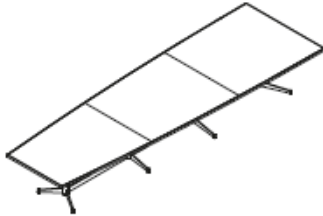

Top..... wood veneered with specified edge detail
Base metal
Corners..... mitered

Specify

Wood
 Edge
 Base

	Product Number	Depth	Width	Height	Basic Price	Base
MP • Rectangular plain wood top 	AM3WMN-2460	24	60	29	\$4,451	+593
	AM3WMN-2466	24	66	29	\$4,488	+593
	AM3WMN-2472	24	72	29	\$4,517	+593
	AM3WMN-3060	30	60	29	\$4,617	+593
	AM3WMN-3066	30	66	29	\$4,644	+593
	AM3WMN-3072	30	72	29	\$4,675	+593
	AM3WMN-3078	30	78	29	\$4,704	+593
	AM3WMN-3084	30	84	29	\$4,743	+593
	AM3WMN-3672	36	72	29	\$4,757	+593
	AM3WMN-3678	36	78	29	\$4,787	+593
	AM3WMN-3684	36	84	29	\$4,817	+593

Top.....1 1/4" thick wood veneered with WE3 eased edge detail
 Basemetal
 Corners.....mitered
 Casterssoft or hard, black

Note: Flex tables come pre-drilled for modesty panels and ganging brackets.
 Specify ganging brackets and modesty panels separately.

Specify

- Wood
- Edge (available in WE3 only)
- Base
- Casters

MP Flex Tables

Rectangular • Laminate Top

GEIGER

	Product Number	Depth	Width	Height	Basic Price	Base
MP • Rectangular plain laminate top 	AM3LMN-2460	24	60	29	\$3,815	+593
	AM3LMN-2466	24	66	29	\$3,854	+593
	AM3LMN-2472	24	72	29	\$3,883	+593
	AM3LMN-3060	30	60	29	\$3,980	+593
	AM3LMN-3066	30	66	29	\$4,009	+593
	AM3LMN-3072	30	72	29	\$4,040	+593
	AM3LMN-3078	30	78	29	\$4,070	+593
	AM3LMN-3084	30	84	29	\$4,105	+593
	AM3LMN-3672	36	72	29	\$4,122	+593
	AM3LMN-3678	36	78	29	\$4,152	+593
	AM3LMN-3684	36	84	29	\$4,182	+593

Top..... 1 1/8" thick laminate top with (ECE) PVC eased edge detail
Base metal
Corners..... mitered
Casters soft or hard, black

Note: Flex tables come pre-drilled for modesty panels and ganging brackets.
 Specify ganging brackets and modesty panels separately.

Specify

- Edge (available in ECE only)
- Base
- Casters
- Laminate



	Product Number	Depth	Width	Height	Basic Price	Base
MP • Rectangular wood top with large grommet	AM3WMG-2460	24	60	29	\$4,853	+593
	AM3WMG-2466	24	66	29	\$4,883	+593
	AM3WMG-2472	24	72	29	\$4,916	+593
	AM3WMG-3060	30	60	29	\$5,009	+593
	AM3WMG-3066	30	66	29	\$5,041	+593
	AM3WMG-3072	30	72	29	\$5,070	+593
	AM3WMG-3078	30	78	29	\$5,100	+593
	AM3WMG-3084	30	84	29	\$5,139	+593
	AM3WMG-3672	36	72	29	\$5,152	+593
	AM3WMG-3678	36	78	29	\$5,182	+593
	AM3WMG-3684	36	84	29	\$5,213	+593

Top.....1 1/4" thick wood veneered with WE3 eased edge detail
 Basemetal
 Corners.....mitered
 Casterssoft or hard, black

Note: Flex tables come pre-drilled for modesty panels and ganging brackets.
 Specify ganging brackets and modesty panels separately.

Specify

- Wood
- Edge (available in WE3 only)
- Metal (grommet finish) Base
- Casters

MP Flex Tables

Rectangular • Laminate Top with Grommet

GEIGER

	Product Number	Depth	Width	Height	Basic Price	Base
MP • Rectangular laminate top with large grommet 	AM3LMG-2460	24	60	29	\$4,219	+593
	AM3LMG-2466	24	66	29	\$4,250	+593
	AM3LMG-2472	24	72	29	\$4,278	+593
	AM3LMG-3060	30	60	29	\$4,376	+593
	AM3LMG-3066	30	66	29	\$4,406	+593
	AM3LMG-3072	30	72	29	\$4,434	+593
	AM3LMG-3078	30	78	29	\$4,471	+593
	AM3LMG-3084	30	84	29	\$4,502	+593
	AM3LMG-3672	36	72	29	\$4,517	+593
	AM3LMG-3678	36	78	29	\$4,547	+593
	AM3LMG-3684	36	84	29	\$4,576	+593

Top..... 1 1/8" thick laminate top with (ECE) PVC eased edge detail

Basemetal

Corners..... mitered

Casters soft or hard, black

Note: Flex tables come pre-drilled for modesty panels and ganging brackets. Specify ganging brackets and modesty panels separately.

Specify

Edge (available in ECE only)

Metal (grommet finish)

Base

Casters

Laminate

	Product Number	Depth	Width	Height	Basic Price	Base
MP • Rectangular wood top with power 	AM3WMP-2460	24	60	29	\$5,563	+593
	AM3WMP-2466	24	66	29	\$5,595	+593
	AM3WMP-2472	24	72	29	\$5,624	+593
	AM3WMP-3060	30	60	29	\$5,722	+593
	AM3WMP-3066	30	66	29	\$5,750	+593
	AM3WMP-3072	30	72	29	\$5,789	+593
	AM3WMP-3078	30	78	29	\$5,819	+593
	AM3WMP-3084	30	84	29	\$5,849	+593
	AM3WMP-3672	36	72	29	\$5,863	+593
	AM3WMP-3678	36	78	29	\$5,900	+593
	AM3WMP-3684	36	84	29	\$5,931	+593

Top.....1 1/4" thick wood veneered with WE3 eased edge detail
 Basemetal
 Corners.....mitered
 Casterssoft or hard, black

Note: Flex tables come pre-drilled for modesty panels and ganging brackets.
 Specify ganging brackets and modesty panels separately.

Table includes one power module and one jumper cable.

Specify

- Wood
- Edge (available in WE3 only)
- Base
- Power
- Casters

MP Flex Tables

Rectangular • Laminate Top with Power

GEIGER

	Product Number	Depth	Width	Height	Basic Price	Base
 <p>MP • Rectangular laminated top with power</p>	AM3LMP-2460	24	60	29	\$4,928	+593
	AM3LMP-2466	24	66	29	\$4,958	+593
	AM3LMP-2472	24	72	29	\$4,988	+593
	AM3LMP-3060	30	60	29	\$5,087	+593
	AM3LMP-3066	30	66	29	\$5,115	+593
	AM3LMP-3072	30	72	29	\$5,152	+593
	AM3LMP-3078	30	78	29	\$5,182	+593
	AM3LMP-3084	30	84	29	\$5,213	+593
	AM3LMP-3672	36	72	29	\$5,228	+593
	AM3LMP-3678	36	78	29	\$5,266	+593
	AM3LMP-3684	36	84	29	\$5,297	+593

Top..... 1 1/8" thick laminate top with (ECE) PVC eased edge detail

Base metal

Corners..... mitered

Casters soft or hard, black

Note: Flex tables come pre-drilled for modesty panels and ganging brackets. Specify ganging brackets and modesty panels separately.

Table includes one power module and one jumper cable.

Specify

Edge (available in ECE only)

Base

Power

Casters

Laminate

	Product Number	Depth	Width	Height	Basic Price	Base
MP • Trapezoid plain wood top 	AMZWMN-2160	21	60	29	\$4,743	+593
	AMZWMN-2172	21	72	29	\$4,771	+593
	AMZWMN-2660	26	60	29	\$4,899	+593
	AMZWMN-2672	26	72	29	\$4,928	+593
	AMZWMN-3160	31	60	29	\$5,009	+593
	AMZWMN-3172	31	72	29	\$5,041	+593

Top.....1 1/4" thick wood veneered with WE3 eased edge detail
 Basemetal
 Corners.....mitered
 Casterssoft or hard, black

Note: Flex tables come pre-drilled for modesty panels and ganging brackets.
 Specify ganging brackets and modesty panels separately.

Specify

Wood
 Edge (available in WE3 only)
 Base
 Casters

MP Flex Tables

Trapezoid • Laminate Top

GEIGER

	Product Number	Depth	Width	Height	Basic Price	Base
MP • Trapezoid plain laminate top 	AMZLMN-2160	21	60	29	\$4,227	+593
	AMZLMN-2172	21	72	29	\$4,255	+593
	AMZLMN-2660	26	60	29	\$4,381	+593
	AMZLMN-2672	26	72	29	\$4,412	+593
	AMZLMN-3160	31	60	29	\$4,495	+593
	AMZLMN-3172	31	72	29	\$4,524	+593

Top..... 1 1/8" thick laminate top with (ECE) PVC eased edge detail

Basemetal

Corners..... mitered

Casters soft or hard, black

Note: Flex tables come pre-drilled for modesty panels and ganging brackets. Specify ganging brackets and modesty panels separately.

Specify

Edge (available in ECE only)

Base

Casters

Laminate

	Product Number	Depth	Width	Height	Basic Price	Base
MP • Trapezoid wood top with large grommet 	AMZWMG-2160	21	60	29	\$5,139	+593
	AMZWMG-2172	21	72	29	\$5,169	+593
	AMZWMG-2660	26	60	29	\$5,297	+593
	AMZWMG-2672	26	72	29	\$5,324	+593
	AMZWMG-3160	31	60	29	\$5,406	+593
	AMZWMG-3172	31	72	29	\$5,439	+593

Top.....1 1/4" thick wood veneered with WE3 eased edge detail
 Basemetal
 Corners.....mitered
 Casterssoft or hard, black

Note: Flex tables come pre-drilled for modesty panels and ganging brackets.
 Specify ganging brackets and modesty panels separately.

Specify

- Wood
- Edge (available in WE3 only)
- Metal (grommet finish)
- Base
- Casters

MP Flex Tables

Trapezoid • Laminate Top with Grommet

GEIGER

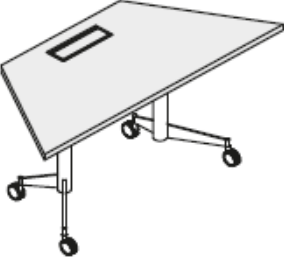
	Product Number	Depth	Width	Height	Basic Price	Base
	AMZLMG-2160	21	60	29	\$4,622	+593
	laminated top with large grommet AMZLMG-2172	21	72	29	\$4,653	+593
	AMZLMG-2660	26	60	29	\$4,780	+593
	AMZLMG-2672	26	72	29	\$4,809	+593
	AMZLMG-3160	31	60	29	\$4,893	+593
	AMZLMG-3172	31	72	29	\$4,921	+593

Top..... 1 1/8" thick laminate top with (ECE) PVC eased edge detail
 Base metal
 Corners..... mitered
 Casters soft or hard, black

Note: Flex tables come pre-drilled for modesty panels and ganging brackets.
 Specify ganging brackets and modesty panels separately.

Specify

- Edge (available in ECE only)
- Metal (grommet finish)
- Base
- Casters
- Laminate

	Product Number	Depth	Width	Height	Basic Price	Base
MP • Trapezoid wood top with power 	AMZWMP-2160	21	60	29	\$5,849	+593
	AMZWMP-2172	21	72	29	\$5,885	+593
	AMZWMP-2660	26	60	29	\$6,004	+593
	AMZWMP-2672	26	72	29	\$6,041	+593
	AMZWMP-3160	31	60	29	\$6,118	+593
	AMZWMP-3172	31	72	29	\$6,148	+593

Top.....1 1/4" thick wood veneered with WE3 eased edge detail
 Basemetal
 Corners.....mitered
 Casterssoft or hard, black

Note: Flex tables come pre-drilled for modesty panels and ganging brackets.
 Specify ganging brackets and modesty panels separately.

Table includes one power module and one jumper cable.

Specify

Wood
 Edge (available in WE3
 only)
 Base
 Power
 Casters

MP Flex Tables

Trapezoid • Laminate Top with Power

GEIGER

	Product Number	Depth	Width	Height	Basic Price	Base
 <p>MP • Trapezoid laminated top with power</p>	AMZLMP-2160	21	60	29	\$5,333	+593
	AMZLMP-2172	21	72	29	\$5,370	+593
	AMZLMP-2660	26	60	29	\$5,496	+593
	AMZLMP-2672	26	72	29	\$5,527	+593
	AMZLMP-3160	31	60	29	\$5,602	+593
	AMZLMP-3172	31	72	29	\$5,639	+593

Top..... 1 1/8" thick laminate top with (ECE) PVC eased edge detail
 Base metal
 Corners..... mitered
 Casters soft or hard, black

Note: Flex tables come pre-drilled for modesty panels and ganging brackets.
 Specify ganging brackets and modesty panels separately.

Table includes one power module and one jumper cable.

Specify

- Edge (available in ECE only)
- Base
- Power
- Casters
- Laminate

	Product Number	Depth	Width	Height	Basic Price	Base
MP • Half Round plain wood top	AMHWMN-48	24	48	29	\$4,669	+593
	AMHWMN-60	30	60	29	\$4,697	+593
	AMHWMN-72	36	72	29	\$4,731	+593



Top.....1 1/4" thick wood veneered with WE3 eased edge detail
 Basemetal
 Casterssoft or hard, black

Note: Flex tables come pre-drilled for modesty panels and ganging brackets. Specify ganging brackets and modesty panels separately.

Specify

- Wood
- Edge (available in WE3 only)
- Base
- Casters

MP Flex Tables

Half Round • Laminate Top

GEIGER

	Product Number	Depth	Width	Height	Basic Price	Base
MP • Half Round plain laminate top	AMHLMN-48	24	48	29	\$4,152	+593
	AMHLMN-60	30	60	29	\$4,182	+593
	AMHLMN-72	36	72	29	\$4,219	+593



Top..... 1 1/8" thick laminate top with (ECE) PVC eased edge detail
 Base metal
 Casters soft or hard, black

Note: Flex tables come pre-drilled for modesty panels and ganging brackets.
 Specify ganging brackets and modesty panels separately.

Specify

- Edge (available in ECE only)
- Base
- Casters
- Laminate

	Product Number	Depth	Width	Height	Basic Price	Base
MP • Half Round wood top with large grommet	AMHWMG-48	24	48	29	\$5,063	+593
	AMHWMG-60	30	60	29	\$5,093	+593
	AMHWMG-72	36	72	29	\$5,129	+593



Top.....1 1/4" thick wood veneered with WE3 eased edge detail
 Basemetal
 Casterssoft or hard, black

Note: Flex tables come pre-drilled for modesty panels and ganging brackets. Specify ganging brackets and modesty panels separately.

Specify

- Wood
- Edge (available in WE3 only)
- Metal (grommet finish) Base
- Casters

MP Flex Tables

Half Round • Laminate Top with Grommet

GEIGER

	Product Number	Depth	Width	Height	Basic Price	Base
MP • Half Round laminite top with large grommet	AMHLMG-48	24	48	29	\$4,547	+593
	AMHLMG-60	30	60	29	\$4,576	+593
	AMHLMG-72	36	72	29	\$4,617	+593



Top..... 1 1/8" thick laminate top with (ECE) PVC eased edge detail

Base metal

Casters soft or hard, black

Note: Flex tables come pre-drilled for modesty panels and ganging brackets. Specify ganging brackets and modesty panels separately.

Specify

Edge (available in ECE only)

Metal (grommet finish)

Base

Casters

Laminate

	Product Number	Depth	Width	Height	Basic Price	Base
MP • Half Round wood top with power	AMHWMP-48	24	48	29	\$5,779	+593
	AMHWMP-60	30	60	29	\$5,811	+593
	AMHWMP-72	36	72	29	\$5,839	+593



Top.....1 1/4" thick wood veneered with WE3 eased edge detail
 Basemetal
 Casterssoft or hard, black

Note: Flex tables come pre-drilled for modesty panels and ganging brackets. Specify ganging brackets and modesty panels separately.

Table includes one power module and one jumper cable.

Specify

- Wood
- Edge (available in WE3 only)
- Base
- Power
- Casters

MP Flex Tables

Half Round • Laminate Top with Power

GEIGER

	Product Number	Depth	Width	Height	Basic Price	Base
MP • Half Round laminite top with power	AMHLMP-48	24	48	29	\$5,266	+593
	AMHLMP-60	30	60	29	\$5,297	+593
	AMHLMP-72	36	72	29	\$5,324	+593



Top..... 1 1/8" thick laminate top with (ECE) PVC eased edge detail
 Base metal
 Casters soft or hard, black

Note: Flex tables come pre-drilled for modesty panels and ganging brackets.
 Specify ganging brackets and modesty panels separately.

Table includes one power module and one jumper cable.

Specify

- Edge (available in ECE only)
- Base
- Power
- Casters
- Laminate

	Product Number	Depth	Width	Height	Basic Price	Base
MP • Video Conf. End Table plain wood top	AMVWMN-48	24	48	29	\$4,869	+593
	AMVWMN-60	30	60	29	\$4,899	+593
	AMVWMN-72	36	72	29	\$4,928	+593



Top.....1 1/4" thick wood veneered with WE3 eased edge detail
 Basemetal
 Casterssoft or hard, black

Note: Flex tables come pre-drilled for modesty panels and ganging brackets.
 Specify ganging brackets and modesty panels separately.

Specify

- Wood
- Edge (available in WE3 only)
- Base
- Casters

MP Flex Tables

Video Conference End Table • Laminate Top

GEIGER

	Product Number	Depth	Width	Height	Basic Price	Base
MP • Video Conf. End Table plain laminate top	AMVLMN-48	24	48	29	\$4,354	+593
	AMVLMN-60	30	60	29	\$4,381	+593
	AMVLMN-72	36	72	29	\$4,412	+593



Top..... 1 1/8" thick laminate top with (ECE) PVC eased edge detail

Basemetal

Casters soft or hard, black

Note: Flex tables come pre-drilled for modesty panels and ganging brackets. Specify ganging brackets and modesty panels separately.

Specify

Edge (available in ECE only)

Base

Casters

Laminate

	Product Number	Depth	Width	Height	Basic Price	Base
MP • Video Conf. End Table wood top with large grommet	AMVWMG-48	24	48	29	\$5,266	+593
	AMVWMG-60	30	60	29	\$5,297	+593
	AMVWMG-72	36	72	29	\$5,324	+593



Top.....1 1/4" thick wood veneered with WE3 eased edge detail
 Basemetal
 Casterssoft or hard, black

Note: Flex tables come pre-drilled for modesty panels and ganging brackets.
 Specify ganging brackets and modesty panels separately.

Specify

Wood
 Edge (available in WE3 only)
 Metal (grommet finish) Base
 Casters

MP Flex Tables

Video Conference End Table • Laminate Top with Grommet

GEIGER

	Product Number	Depth	Width	Height	Basic Price	Base
MP • Video Conf. End Table laminite top with large grommet	AMVLMG-48	24	48	29	\$4,751	+593
	AMVLMG-60	30	60	29	\$4,780	+593
	AMVLMG-72	36	72	29	\$4,809	+593



Top..... 1 1/8" thick laminate top with (ECE) PVC eased edge detail

Basemetal

Casters soft or hard, black

Note: Flex tables come pre-drilled for modesty panels and ganging brackets. Specify ganging brackets and modesty panels separately.

Specify

Edge (available in ECE only)

Metal (grommet finish)

Base

Casters

Laminate

	Product Number	Depth	Width	Height	Basic Price	Base
MP • Video Conf. End Table wood top with power	AMVWMP-48	24	48	29	\$5,973	+593
	AMVWMP-60	30	60	29	\$6,004	+593
	AMVWMP-72	36	72	29	\$6,041	+593



Top.....1 1/4" thick wood veneered with WE3 eased edge detail
 Basemetal
 Casterssoft or hard, black

Note: Flex tables come pre-drilled for modesty panels and ganging brackets.
 Specify ganging brackets and modesty panels separately.

Table includes one power module and one jumper cable.

Specify

Wood
 Edge (available in WE3 only)
 Base
 Power
 Casters

MP Flex Tables

Video Conference End Table • Laminate Top with Power

GEIGER

	Product Number	Depth	Width	Height	Basic Price	Base
MP • Video Conf. End Table laminite top with power	AMVLMP-48	24	48	29	\$5,456	+593
	AMVLMP-60	30	60	29	\$5,596	+593
	AMVLMP-72	36	72	29	\$5,527	+593



Top..... 1 1/8" thick laminate top with (ECE) PVC eased edge detail
 Base metal
 Casters soft or hard, black

Note: Flex tables come pre-drilled for modesty panels and ganging brackets.
 Specify ganging brackets and modesty panels separately.

Table includes one power module and one jumper cable.

Specify

- Edge (available in ECE only)
- Base
- Power
- Casters
- Laminate

	Product Number	Depth	Width	Height	Basic Price
MP • Modesty Panel wood 	AMMWM-24	3/4	23 1/2	7 1/2	\$1,016
	AMMWM-30	3/4	29 1/2	7 1/2	\$1,029
	AMMWM-36	3/4	35 1/2	7 1/2	\$1,044
	AMMWM-42	3/4	41 1/2	7 1/2	\$1,059
	AMMWM-48	3/4	47 1/2	7 1/2	\$1,074
	AMMWM-60	3/4	59 1/2	7 1/2	\$1,088
	AMMWM-66	3/4	65 1/2	7 1/2	\$1,111
	AMMWM-72	3/4	71 1/2	7 1/2	\$1,126
	AMMWM-78	3/4	77 1/2	7 1/2	\$1,141
	AMMWM-84	3/4	83 1/2	7 1/2	\$1,157

Specify
 Wood

MP Flex Tables

Modesty Panel • Laminate

GEIGER

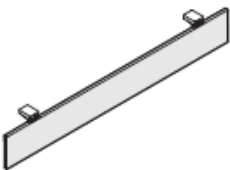
	Product Number	Depth	Width	Height	Basic Price
MP • Modesty Panel laminate 	AMMLM-24	3/4	23 1/2	7 1/2	\$860
	AMMLM-30	3/4	29 1/2	7 1/2	\$871
	AMMLM-36	3/4	35 1/2	7 1/2	\$887
	AMMLM-42	3/4	41 1/2	7 1/2	\$900
	AMMLM-48	3/4	47 1/2	7 1/2	\$918
	AMMLM-60	3/4	59 1/2	7 1/2	\$932
	AMMLM-66	3/4	65 1/2	7 1/2	\$947
	AMMLM-72	3/4	71 1/2	7 1/2	\$969
	AMMLM-78	3/4	77 1/2	7 1/2	\$985
	AMMLM-84	3/4	83 1/2	7 1/2	\$999

Specify

Laminate

	Product Number	Depth	Width	Height	Basic Price
MP • Rounded Corner wood	AMCWMN-2424	24	24	1 1/4	\$1,946
	AMCWMN-3030	30	30	1 1/4	\$2,043
	AMCWMN-3636	36	36	1 1/4	\$2,156

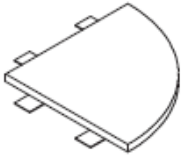

*Note: Rounded corner does not include power jumper cable.
Specify **AMPPJ-12** for 24" or 30" rounded corners and **AMPPJ-24** for 36" rounded corners.*

Specify

Wood
Edge (available in LVS only)

MP Flex Tables

Rounded Corner • Laminate

GEIGER

	Product Number	Depth	Width	Height	Basic Price
MP • Rounded Corner laminate	AMCLMN-2424	24	24	1 1/8	\$1,642
	AMCLMN-3030	30	30	1 1/8	\$1,732
	AMCLMN-3636	36	36	1 1/8	\$1,843

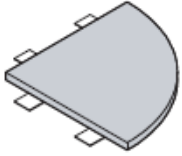

*Note: Rounded corner does not include power jumper cable.
Specify **AMPPJ-12** for 24" or 30" rounded corners and **AMPPJ-24** for 36" rounded corners.*

Specify

Edge (available in ECE only)
Laminate

	Product Number	Basic Price
MP • Ganging Hardware For MP Flex Tables	AMGM-1	\$124

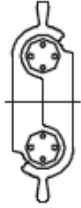

Note: Order one ganging kit for each side connection and two ganging kits for each back to back connection.

All rectangular, trapezoid and half-round tables are pre-drilled to accept ganging brackets.

Specify

MP Flex Tables

Jumper Cables

GEIGER

	Product Number	Basic Price
MP • Jumper Cables For MP Flex Tables	<i>MP Flex, Power, Interlink IQ 2.0 By-Pass Jumper Cable</i>	
	AMPPJ-12N	\$154
	AMPPJ-24N	\$154
	AMPPJ-36N	\$154
	AMPPJ-48N	\$154
	AMPPJ-60N	\$154

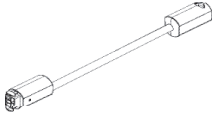

Note: multiple jumper cables may be required depending on width of table

Specify

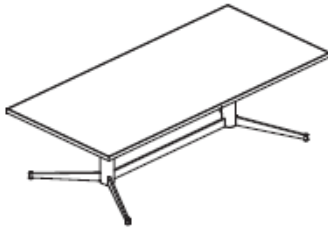
	Product Number	Depth	Width	Basic Price	Base
MP Height Adjustable rectangular with wood top 	<i>1 1/4" wood top</i>				
	AM3HWA-3060	30	60	\$7,849	+1,082
	AM3HWA-3066	30	66	\$7,985	+1,082
	AM3HWA-3072	30	72	\$8,112	+1,082
	AM3HWB-3660	36	60	\$8,112	+1,082
	AM3HWB-3666	36	66	\$8,311	+1,082
	AM3HWB-3672	36	72	\$8,448	+1,082
	AM3HWB-3678	36	78	\$8,597	+1,082
	AM3HWB-3684	36	84	\$8,812	+1,082
	AM3HWB-4278	42	78	\$8,939	+1,082
	AM3HWB-4284	42	84	\$9,187	+1,082
	AM3HWB-4290	42	90	\$9,366	+1,082
	AM3HWB-4296	42	96	\$9,554	+1,082
	AM3HWB-4884	48	84	\$9,554	+1,082
	AM3HWB-4890	48	90	\$9,755	+1,082
	AM3HWB-4896	48	96	\$9,964	+1,082

Top.....wood veneered with specified edge detail
 Basemetal with black top

Specify

Wood
 Edge
 Base
 Plug Strip

Table adjustable height range is 27" to 52-1/2".
 Table includes one plug-in or hardwired under-table plug strip.

MP Height Adjustable Tables

Rectangular • Glass Top

GEIGER

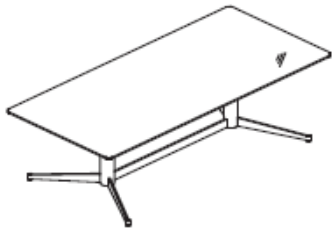
	Product Number	Depth	Width	Basic Price	Base
MP Height Adjustable rectangular with glass top 	<i>Glass top</i>				
	AM3HBB-3060	30	60	\$9,800	+1,082
	AM3HBB-3066	30	66	\$10,059	+1,082
	AM3HBB-3072	30	72	\$10,332	+1,082
	AM3HBB-3660	36	60	\$10,332	+1,082
	AM3HBB-3666	36	66	\$10,681	+1,082
	AM3HBB-3672	36	72	\$10,974	+1,082

Top..... 1/2" thick with polished flat edge and a 3/4" thick painted sub top
 Basemetal with black top

Specify

Glass
 Paint
 Base
 Plug Strip

Table adjustable height range is 27" to 52-1/2".
 Table includes one plug-in or hardwired under-table plug strip.

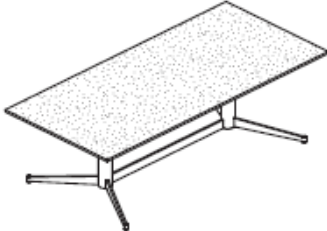
	Product Number	Depth	Width	Basic Price	Base
MP Height Adjustable rectangular with marble top 	<i>marble/stone top</i>				
	AM3HSB-3060	30	60	\$15,015	+1,082
	AM3HSB-3066	30	66	\$15,801	+1,082
	AM3HSB-3072	30	72	\$16,582	+1,082
	AM3HSB-3660	36	60	\$16,582	+1,082
	AM3HSB-3666	36	66	\$17,579	+1,082
	AM3HSB-3672	36	72	\$18,494	+1,082

Top.....3/4" marble/stone top with eased edge and 3/4" painted subtop
Basemetal with black top

Specify

Stone
 Paint
 Base
 Plug Strip

Table adjustable height range is 27" to 52-1/2".
 Table includes one plug-in or hardwired under-table plug strip.

MP Height Adjustable Tables

Oblong MP Height Adjustable

GEIGER

	Product Number	Depth	Width	Basic Price	Base
MP Height Adjustable oblong with wood top 	<i>1 1/4" wood top</i>				
	AM5HWB-4278	42	78	\$8,926	+1,082
	AM5HWB-4284	42	84	\$9,105	+1,082
	AM5HWB-4290	42	90	\$9,291	+1,082
	AM5HWB-4884	48	84	\$9,473	+1,082
	AM5HWB-4890	48	90	\$9,738	+1,082
	AM5HWB-4896	48	96	\$9,949	+1,082

Top.....wood veneered with specified edge detail
Basemetal with black top

Specify	
Wood	Table adjustable height range is 27" to 52-1/2".
Edge	Table includes one plug-in or hardwired under-table plug strip.
Base	
Plug Strip	

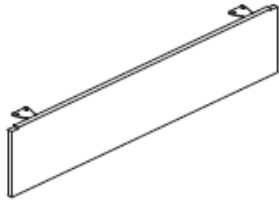
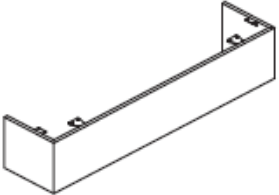
	Product Number	Depth	Width	Height	Basic Price
MP • Modesty Panel wood or painted 	<i>wood, vertical grain</i>				
	AMMHV-5612	3/4	55 3/4	12 1/4	\$974
	AMMHV-6812	3/4	67 3/4	12 1/4	\$1,096
	<i>painted</i>				
	AMMHP-5612	3/4	55 3/4	12 1/4	\$860
	AMMHP-6812	3/4	67 3/4	12 1/4	\$918
MP • Modesty U Panel wood or painted 	<i>wood, vertical grain</i>				
	AMMHVU-5612	3/4	55 3/4	12 1/4	\$1,440
	AMMHVU-6812	3/4	67 3/4	12 1/4	\$1,567
	<i>painted</i>				
	AMMHPU-5612	3/4	55 3/4	12 1/4	\$1,329
	AMMHPU-6812	3/4	67 3/4	12 1/4	\$1,387

Specify

Wood (for wood products)
 Paint (for painted products)

<i>Product Number</i>	<i>Page</i>	<i>Product Number</i>	<i>Page</i>	<i>Product Number</i>	<i>Page</i>	<i>Product Number</i>	<i>Page</i>
AM1BB	27	AM2WB	34	AM3WVG	65	AMMHV	97
AM1BF	23	AM2WD	34	AM3WMN	63	AMMHVU.....	97
AM1BK	25	AM2WF.....	30	AM3WMP	67	AMMLM	88
AM1BP	29	AM2WH	30	AM4WF.....	57,58,59	AMMWM.....	87
AM1CC.....	29	AM2WK	32	AM5BB	56	AMPPJ	92
AM1CD.....	27	AM2WM.....	32	AM5BK	50	AMVLMG.....	84
AM1CL.....	25	AM2WP	36	AM5WB	51	AMVLMN.....	82
AM1CO.....	23	AM2WR	36	AM5WD	52	AMVLMP.....	86
AM1WB	26	AM3BB	48	AM5WK	49	AMVVMG.....	83
AM1WD.....	26	AM3BK	41	AM5WM.....	49	AMVVMN.....	81
AM1WF.....	22	AM3CD	47	AM8WF.....	53,54,55	AMVWMP.....	85
AM1WH.....	22	AM3CL	40	AM9WF.....	60,61,62	AMZLMG.....	72
AM1WK	24	AM3HBB.....	94	AMCLMN.....	90	AMZLMN.....	70
AM1WM.....	24	AM3HSB.....	95	AMCWMN.....	89	AMZLMP.....	74
AM1WP	28	AM3HWA.....	93	AM5HWB.....	96	AMZWVG.....	71
AM1WR	28	AM3HWB.....	93	AMGM	91	AMZWVN.....	69
AM2BB	35	AM3LMG.....	66	AMHLMG.....	78	AMZWVP.....	73
AM2BF	31	AM3LMN.....	64	AMHLMN.....	76		
AM2BK	33	AM3LMP.....	68	AMHLMP.....	80		
AM2BP	37	AM3WB	42	AMHWVG.....	77		
AM2CC.....	37	AM3WD	43	AMHVMN.....	75		
AM2CD.....	35	AM3WF.....	44,45,46	AMHWVP.....	79		
AM2CL.....	33	AM3WK	38	AMMHP	97		
AM2CO.....	31	AM3WM.....	39	AMMHPU.....	97		

MP™ Tables were designed by Amir Paknya

© 2018 Geiger International, Inc. All rights reserved.

® Geiger International is a registered trademark of Geiger International, Inc.

™ The Geiger logo, MP Tables, and MP Flex Tables are trademarks of Geiger International, Inc., and/or of its independent designers.